

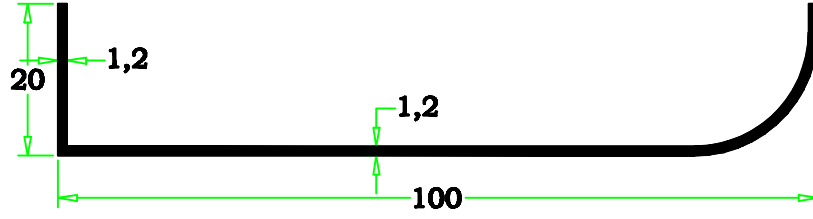

ÖZEN ALÜMİNYUM YAZI TAHTASI PROFİLLERİ

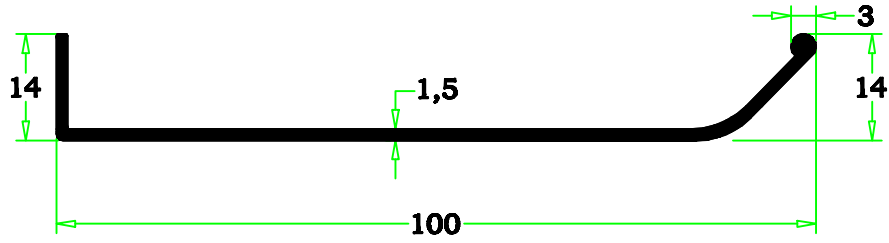

85-84
0,419 kg/m



2004-143
0,490 kg/m

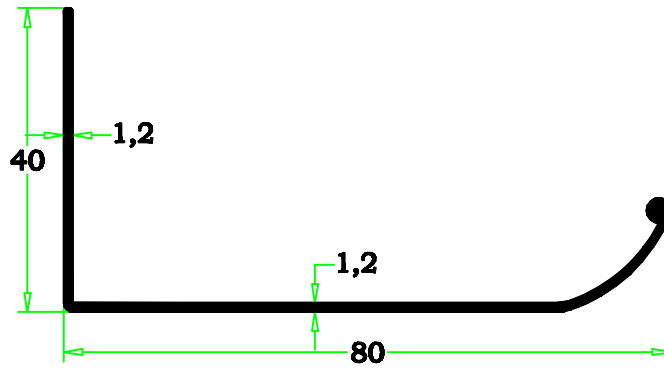

2004-93
0,414 kg/m

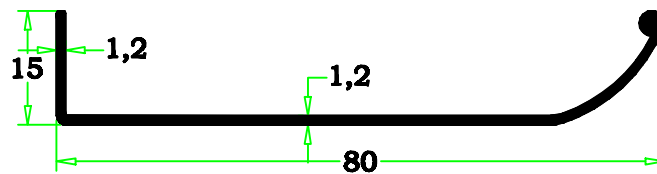

2001-108
0,331 kg/m



ÖZEN ALÜMİNYUM YAZI TAHTASI PROFİLLERİ

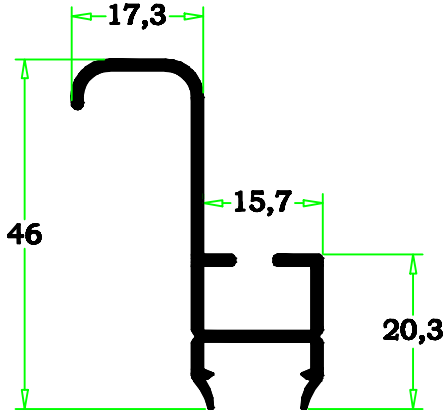

85-91
0,425 kg/m

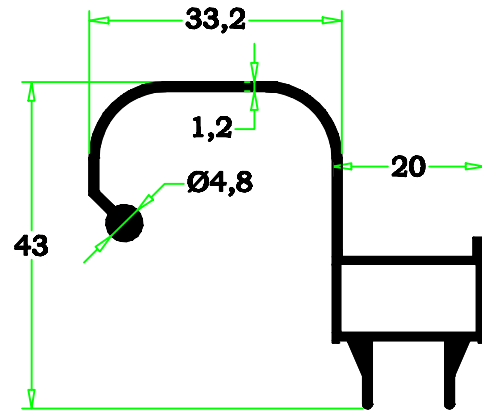

99-38
0,506 kg/m

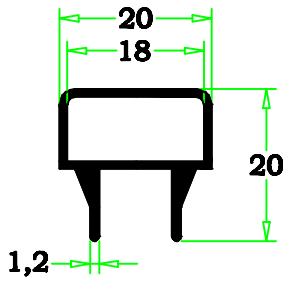

99-40
0,238 kg/m

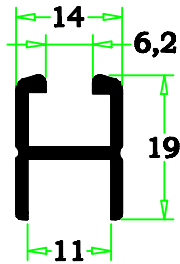

2001-109
0,216 kg/m

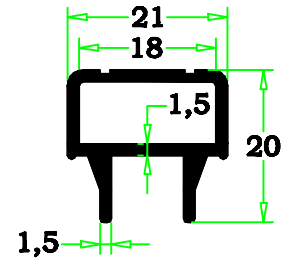

2005-15
0,322 kg/m

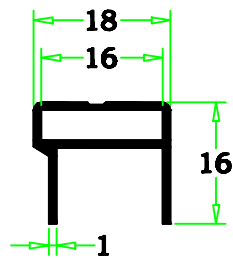

99-39
0,172 kg/m

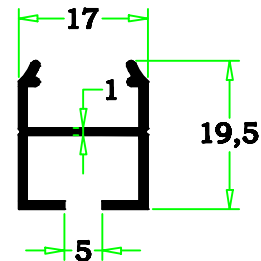

85-90
0,193 kg/m