

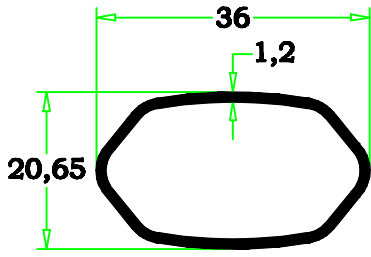

# ÖZEN ALÜMİNYUM ÇAYDANLIK PROFİLLERİ

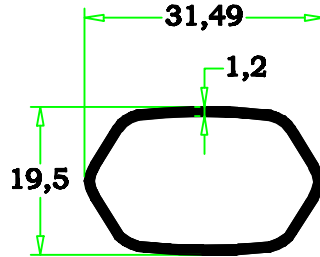

2000-98  
0,286 kg/m



2001-19  
0.259 kg/m

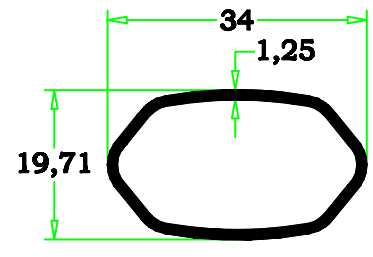

2000-97  
0,282 kg/m

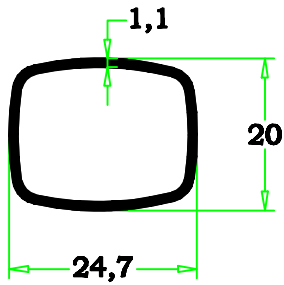

2001-94  
0.222 kg/m

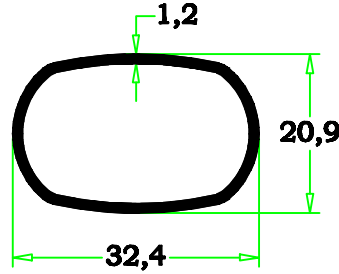

2003-105  
0.275 kg/m

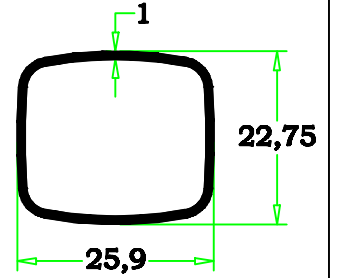

2002-195  
0,224 kg/m

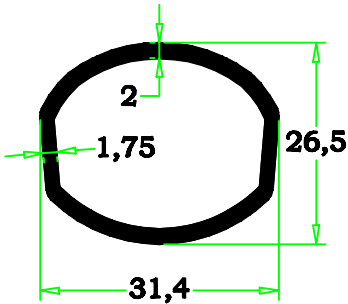

2007-79  
0.460 kg/m

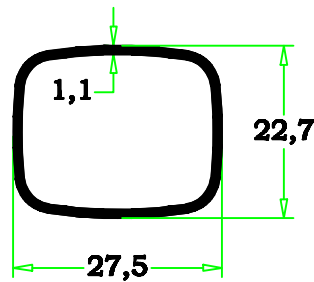

2001-95  
0.252 kg/m

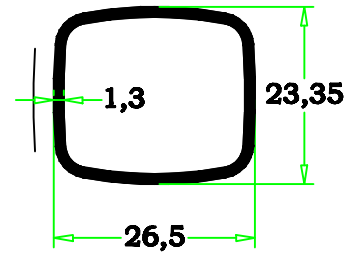

2000-96  
0,295 kg/m

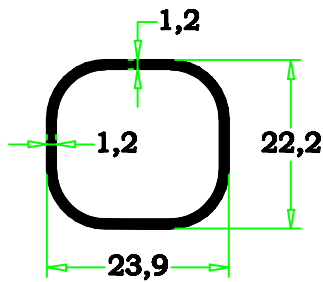

2007-07  
0,245 kg/m

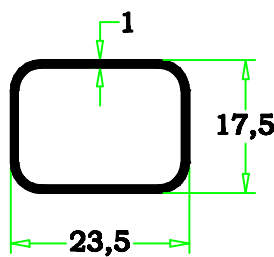

2003-133  
0,194 kg/m

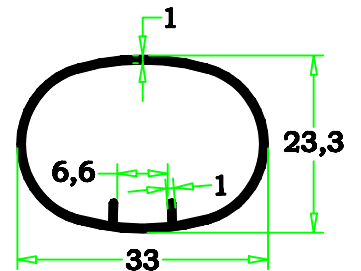

2008-22  
0,255 kg/m



# ÖZEN ALÜMİNYUM ÇAYDANLIK PROFİLLERİ

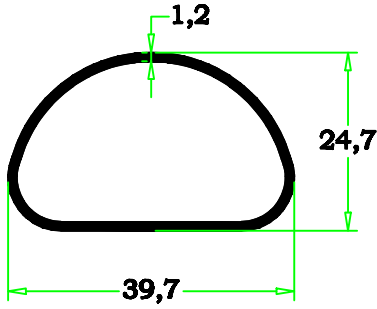

2004-129  
0,332 kg/m

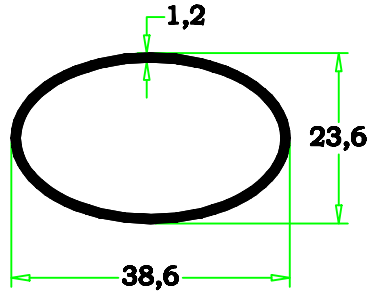

79-106  
0,309 kg/m

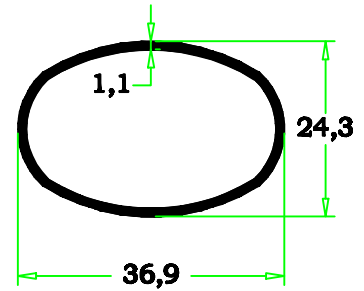

2004-132  
0,283 kg/m

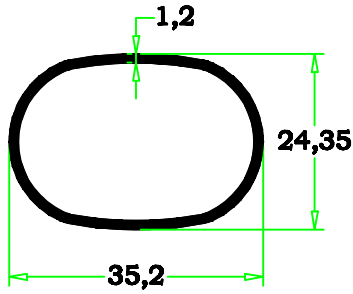

2003-157  
0,304 kg/m

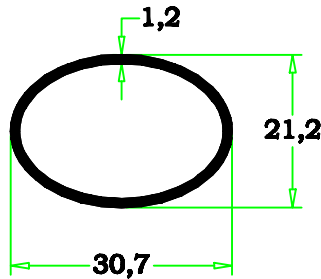

79-98  
0,254 kg/m

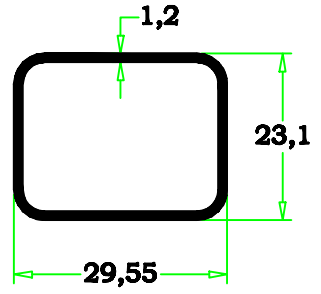

88-94  
0,305 kg/m

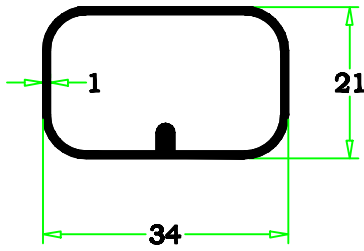

2002-1  
0,284 kg/m

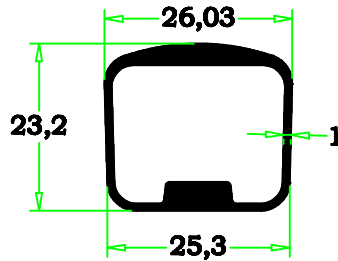

2003-37  
0,389 kg/m

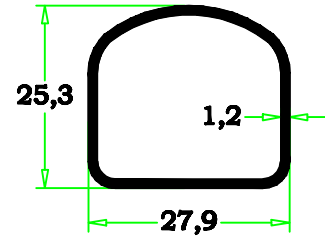

2005-115  
0,293 kg/m

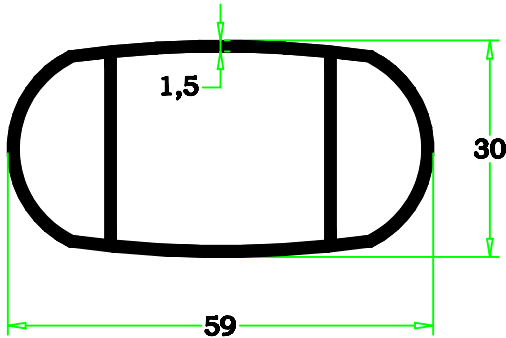

2002-2  
0,799 kg/m

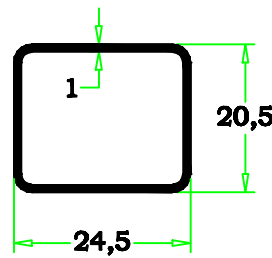

2002-54  
0,233 kg/m

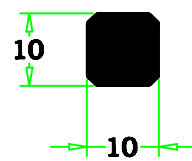

2000-95  
0,253 kg/m

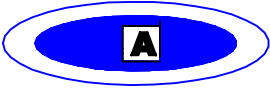

# ÖZEN ALÜMİNYUM ÇAYDANLIK PROFİLLERİ

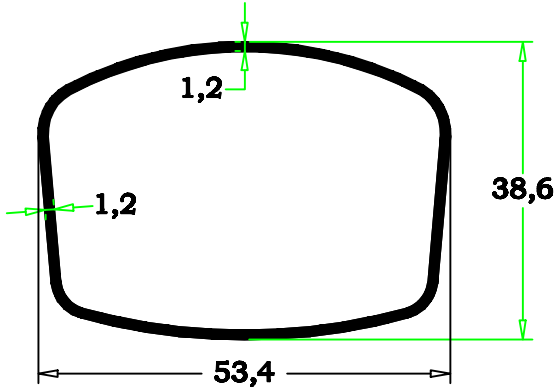

**2005-28**  
**0,500 kg/m**

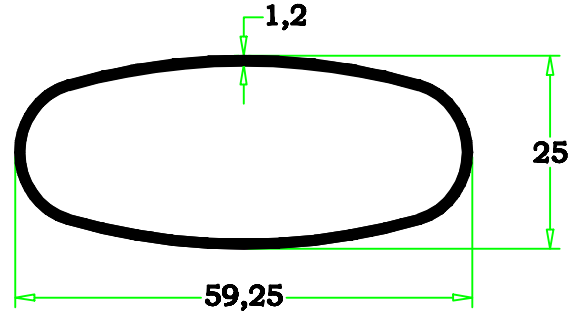

**2004-115**  
**0,449 kg/m**

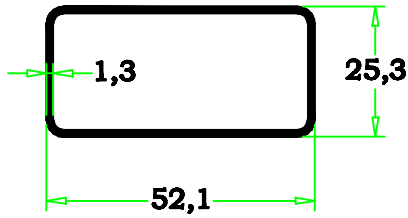

**2004-09**  
**0,511 kg/m**

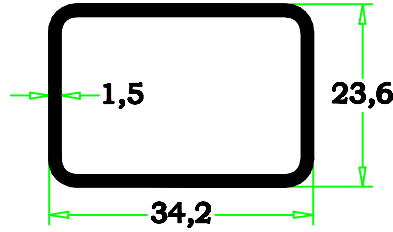

**2006-18**  
**0,426 kg/m**

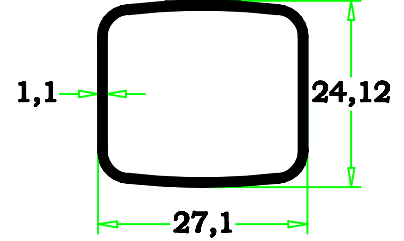

**2004-11**  
**0,268 kg/m**

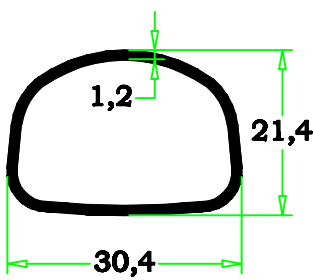

**2006-02**  
**0,270 kg/m**

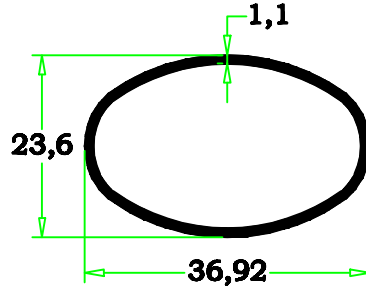

**2005-01**  
**0,278 kg/m**



**2004-77**  
**0,329 kg/m**

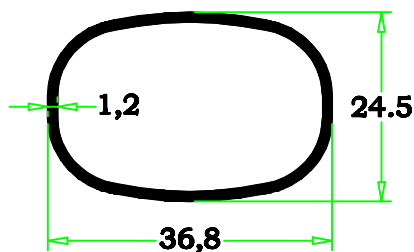

**2004-83**  
**0,319 kg/m**

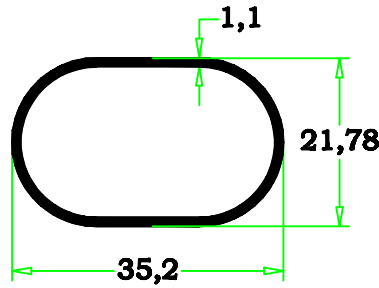

**2003-186**  
**0,272 kg/m**

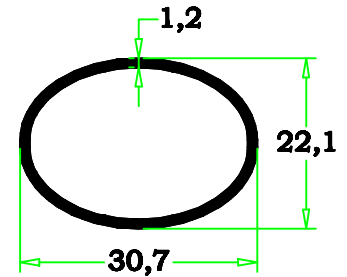

**2004-155**  
**0,257 kg/m**



# ÖZEN ALÜMİNYUM ÇAYDANLIK PROFİLLERİ

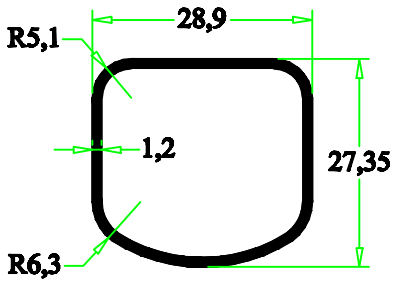

**2006-114**  
0,310 kg/m

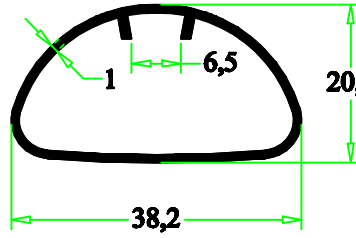

**2006-79**  
0,275 kg/m

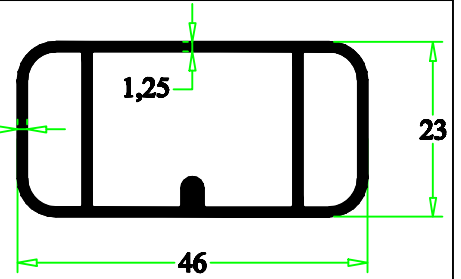

**2004-144**  
0,594 kg/m

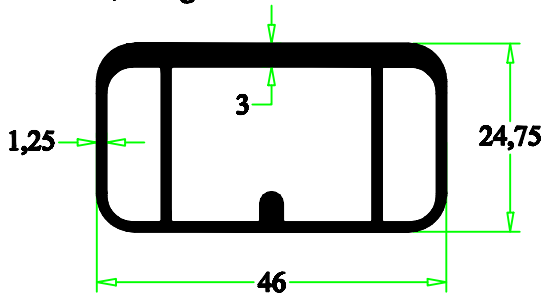

**2005-125**  
0,808 kg/m

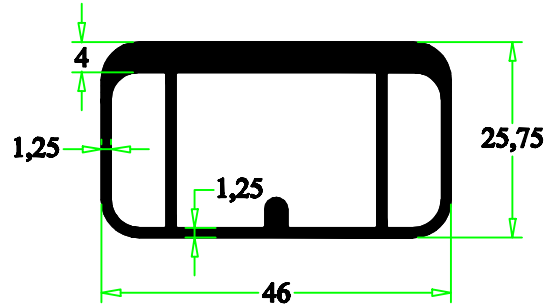

**2005-32**  
0,935 kg/m

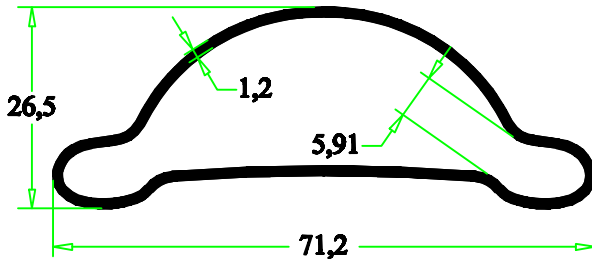

**2006-104**  
0,532 kg/m

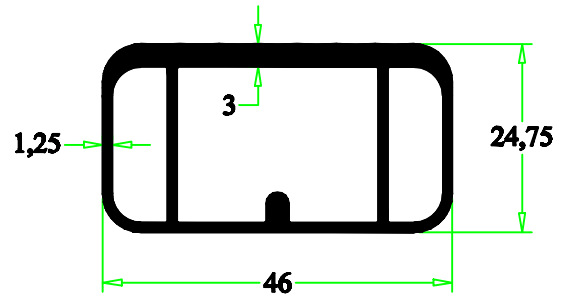

**2005-126**  
0,806 kg/m

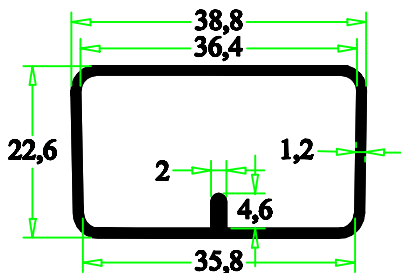

**2006-106**  
0,391 kg/m

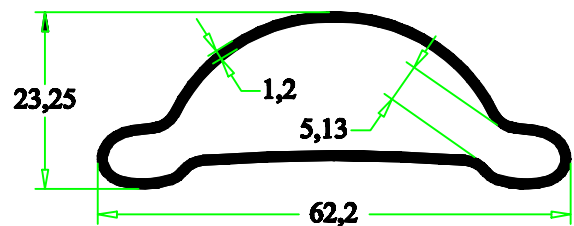

**2006-105**  
0,463 kg/m

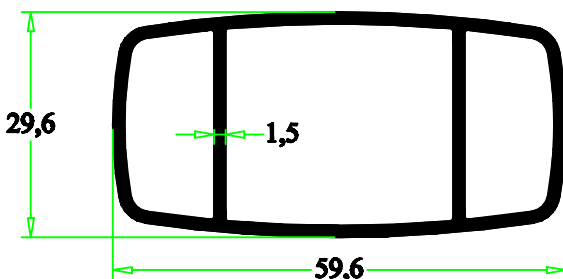

**2010-100**  
0,292 kg/m

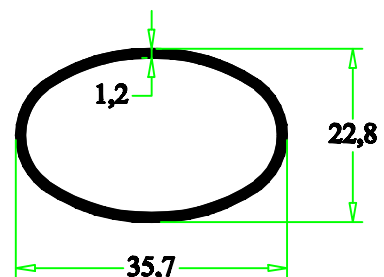

**2006-65**  
0,292 kg/m