

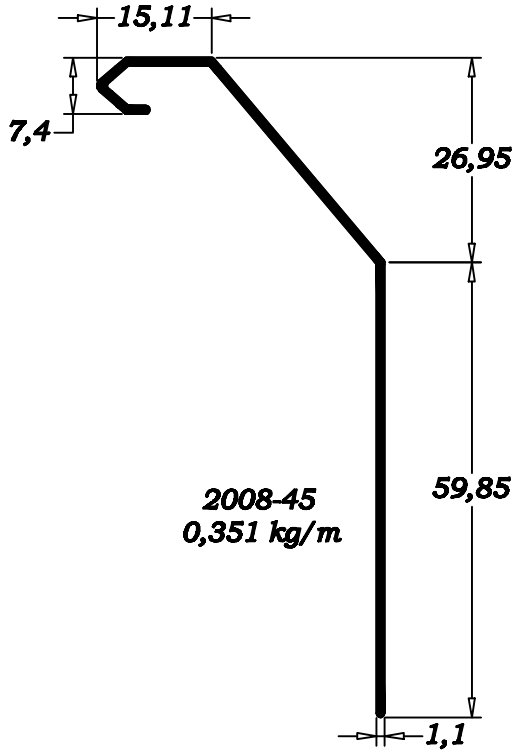

ÖZEN ALÜMİNYUM DİLATASYON PROFİLLERİ

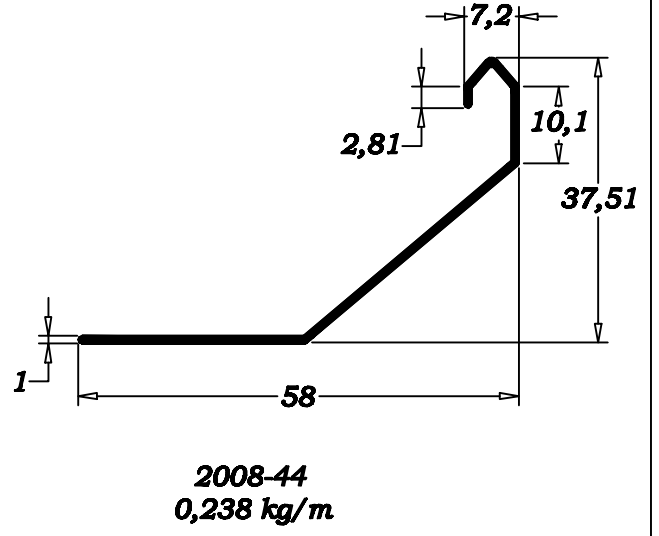

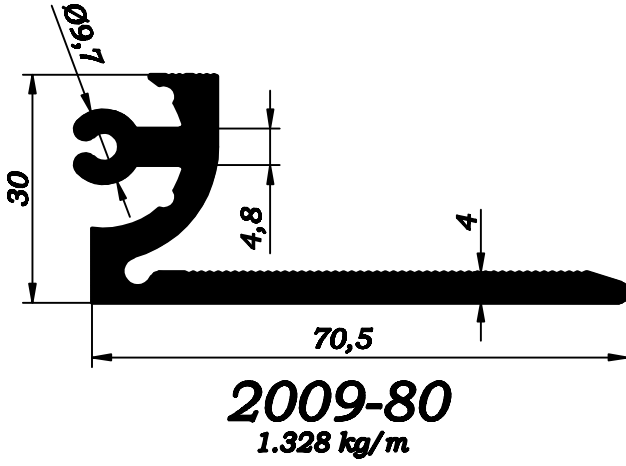
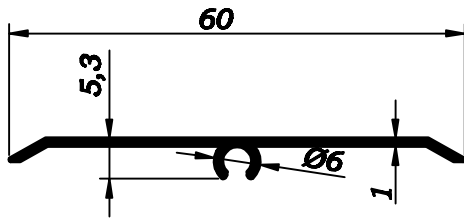

2009-87
0,189 kg/m

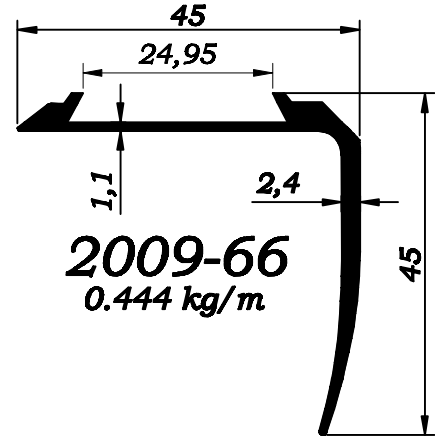

2009-66
0,444 kg/m

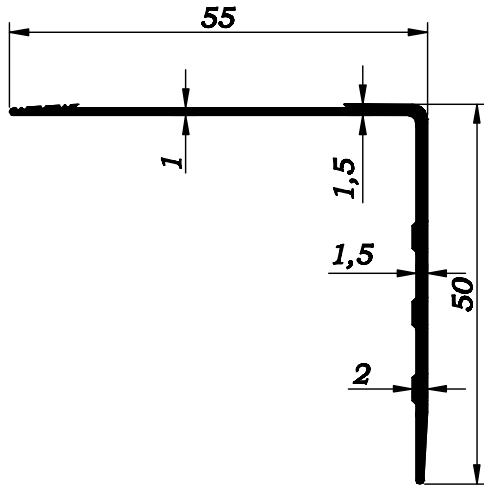

2011-13
0,369 kg/m

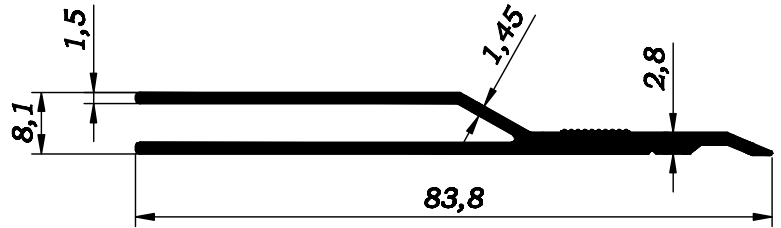

2011-23
0,639 kg/m

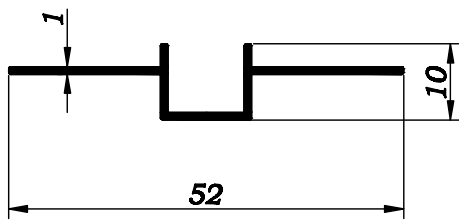

2011-32
0,189 kg/m

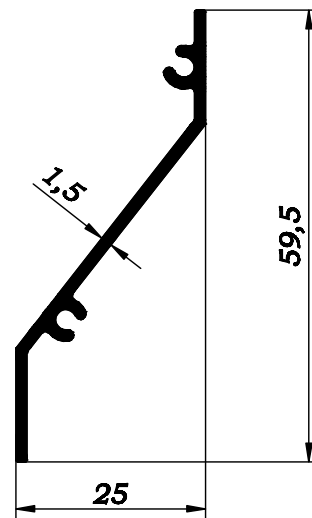

2011-33
0,333 kg/m



ÖZEN ALÜMİNYUM DİLATASYON PROFİLLERİ

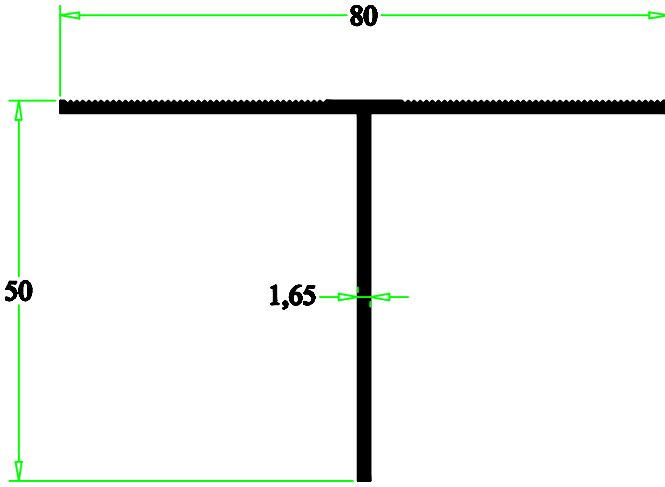

2006-119
0,537 kg/m

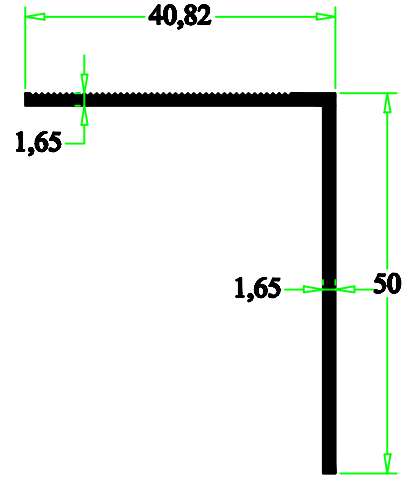

2006-118
0,380 kg/m

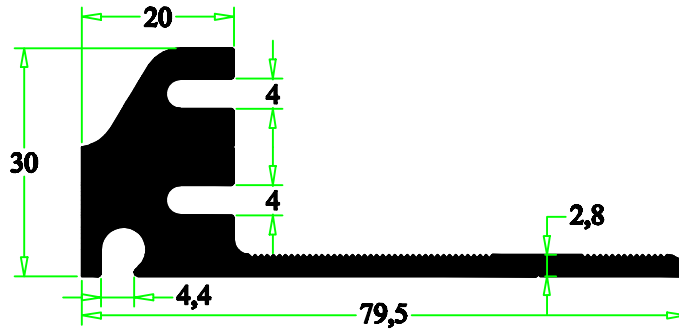

2006-115
1,558 kg/m

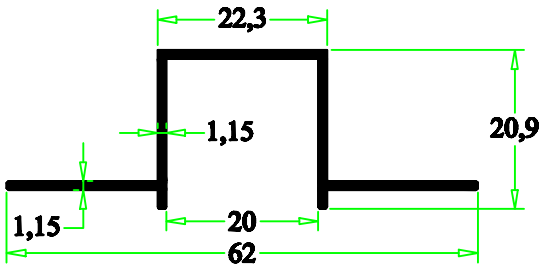

2006-113
0,316 kg/m

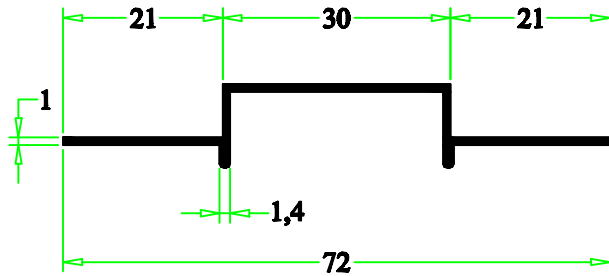

2008-40
0,255 kg/m



ÖZEN ALÜMİNYUM DİLATASYON PROFİLLERİ

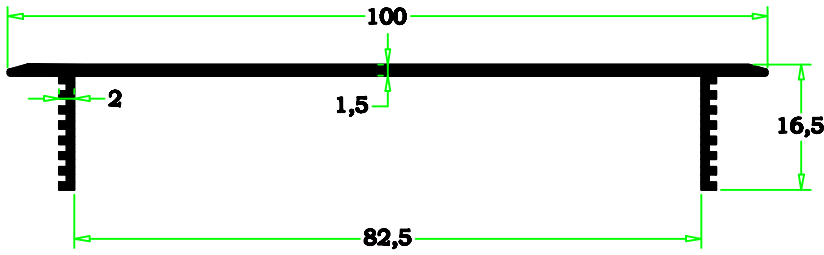

2009-02
0,526 kg/m

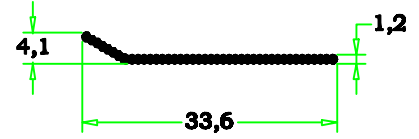

2010-106
0,092 kg/m

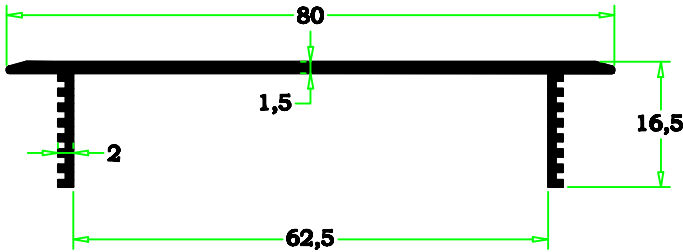

2009-03
0,445 kg/m

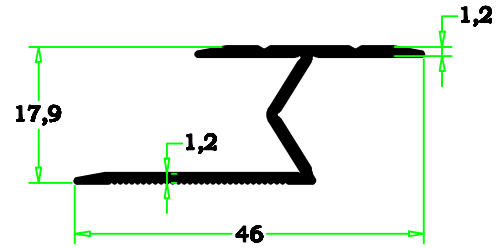

2010-01
0,231 kg/m

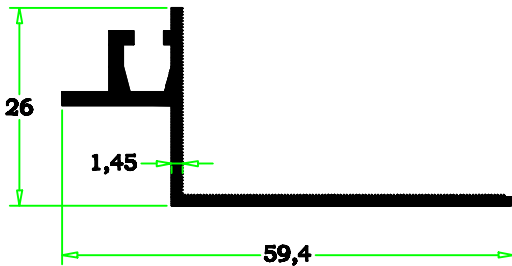

2010-32
0,374 kg/m

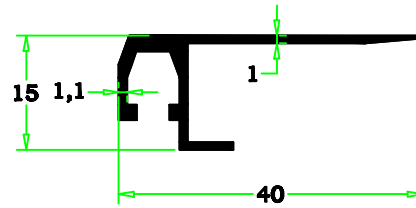

2010-93
0,229 kg/m

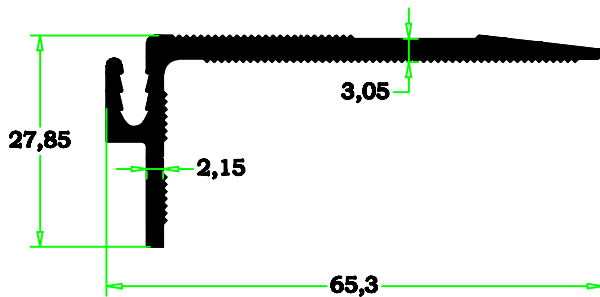

2010-94
0,667 kg/m

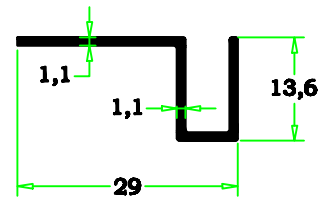

2010-103
0,161 kg/m



ÖZEN ALÜMİNYUM DİLATASYON PROFİLLERİ

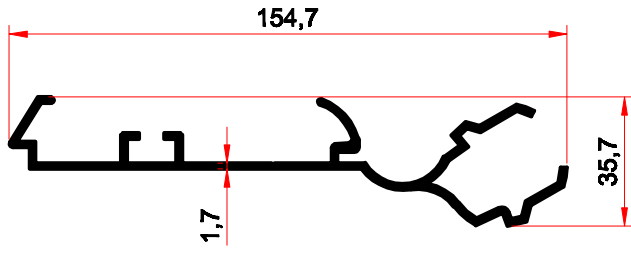

2008-21-B
1.346 kg/m

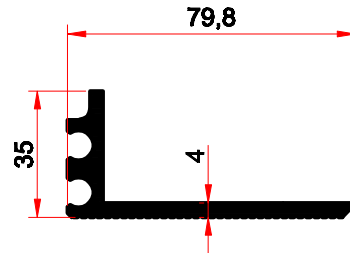

2008-45-B
1.227 kg/m

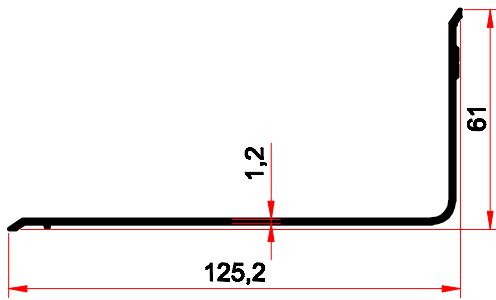

2008-47-B
0.605 kg/m

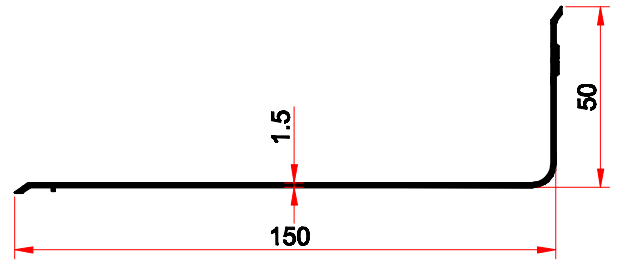

2938
0,819 kg/m

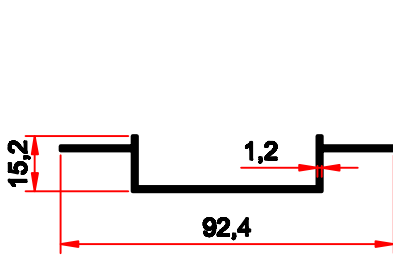

2988
0,391 kg/m

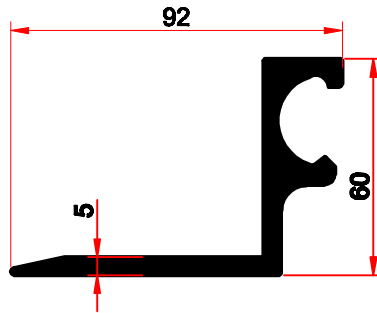

2989
2,315 kg/m

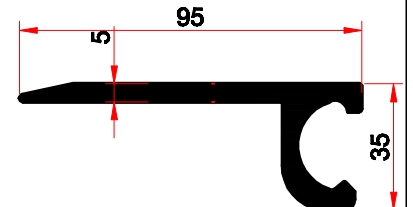

2990
1,897 kg/m

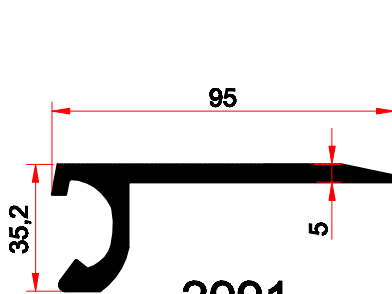

2991
1,823 kg/m

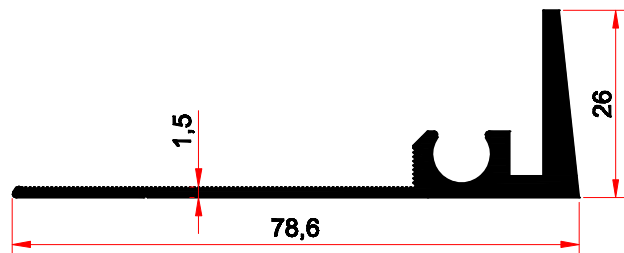

3002
0,686 kg/m



ÖZEN ALÜMİNYUM DİLATASYON PROFİLLERİ

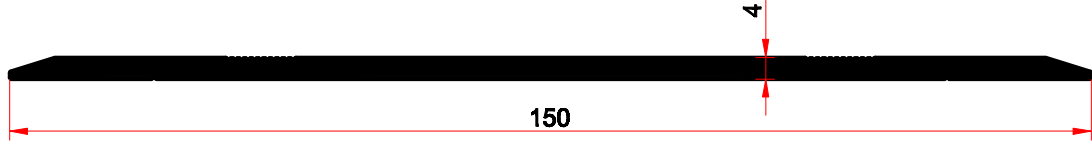

3017
1,567 kg/m

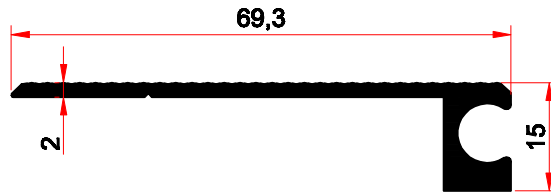

3020
0,533 kg/m

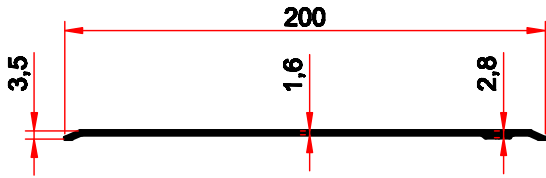

3036
0.891 kg/m

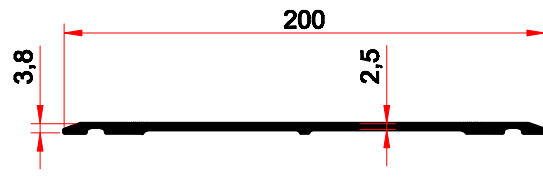

3037
1.447 kg/m

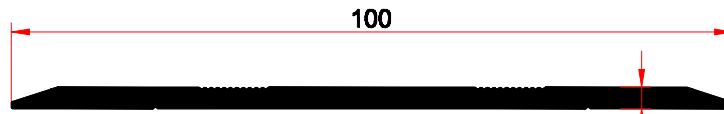

3044
0,848 kg/m

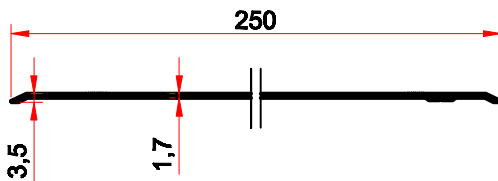

3075
1.170 kg/m

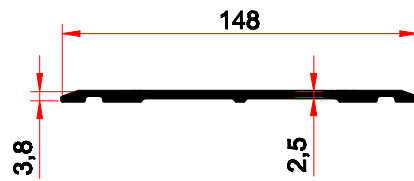

3078
1,095 kg/m



ÖZEN ALÜMİNYUM DİLATASYON PROFİLLERİ

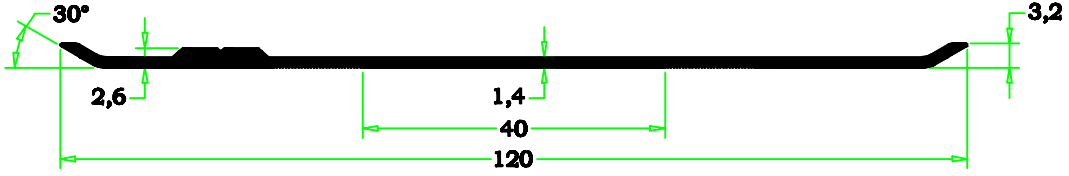

2002-182
0,478 kg/m

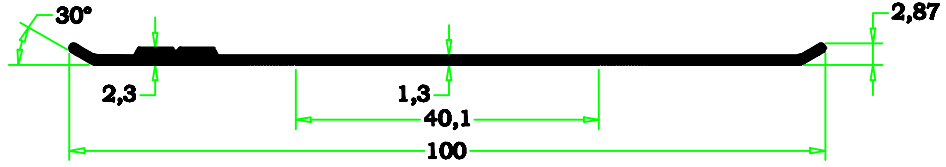

2002-180
0,373 kg/m

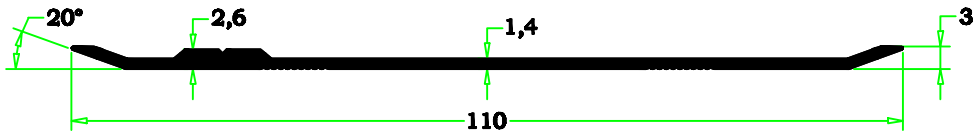

2004-124
0,445 kg/m

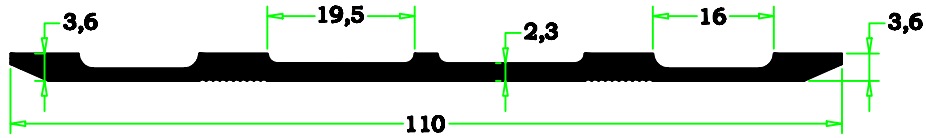

2004-123
0,741 kg/m

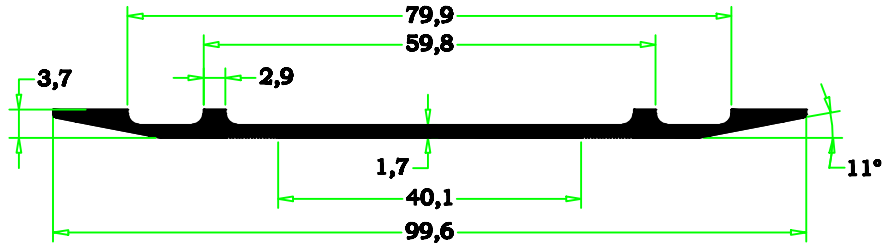

2002-179
0,493 kg/m

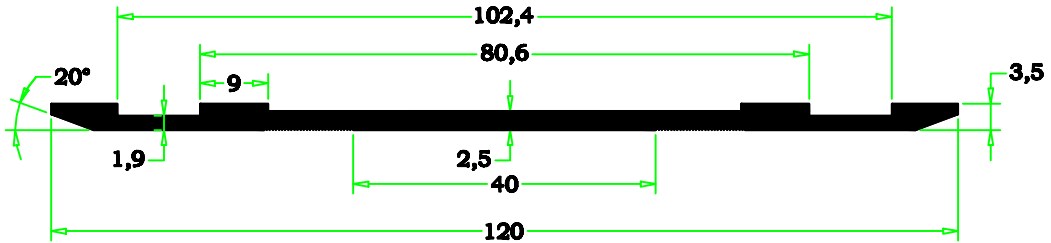

2002-181
0,829 kg/m

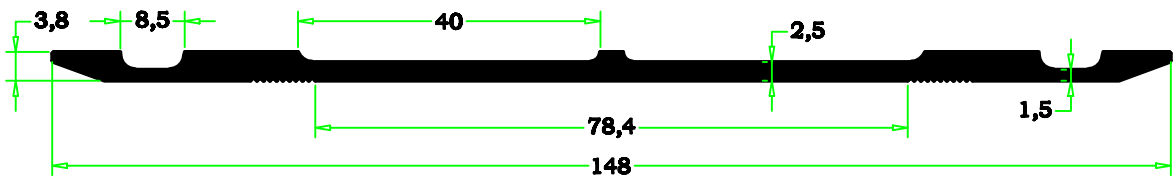

2008 - 23
1,095 kg/m



ÖZEN ALÜMİNYUM DİLATASYON PROFİLLERİ

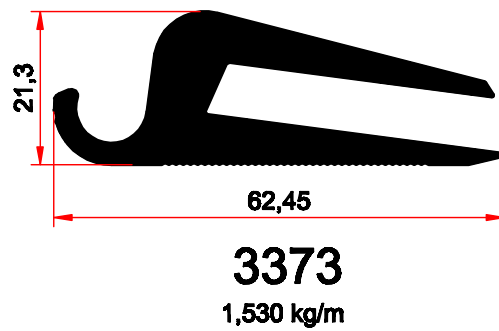
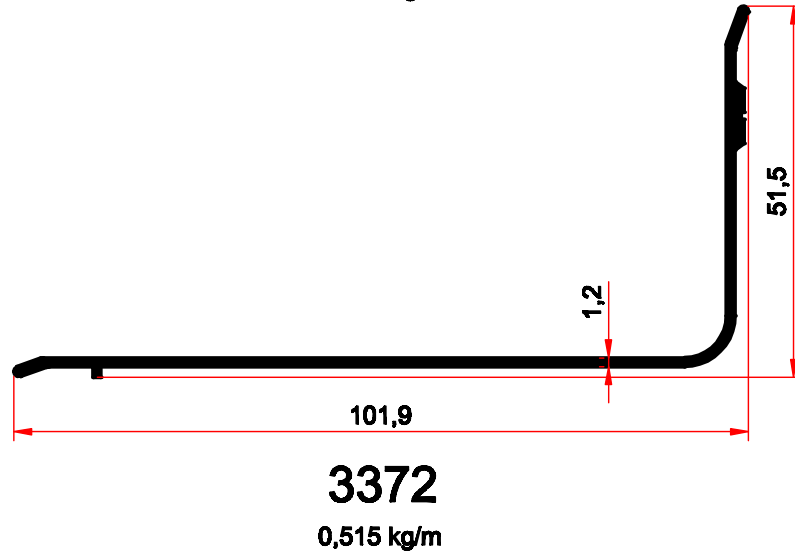
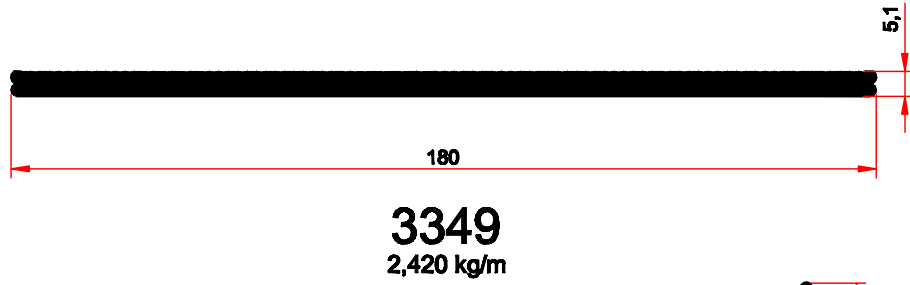
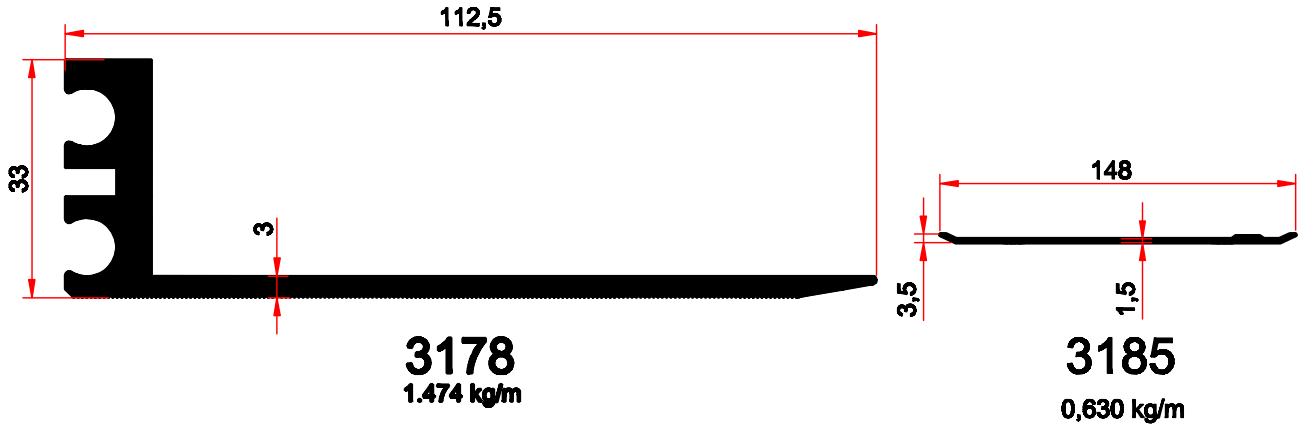

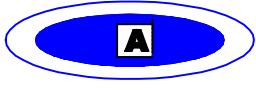

ÖZEN ALÜMİNYUM DİLATASYON PROFİLLERİ

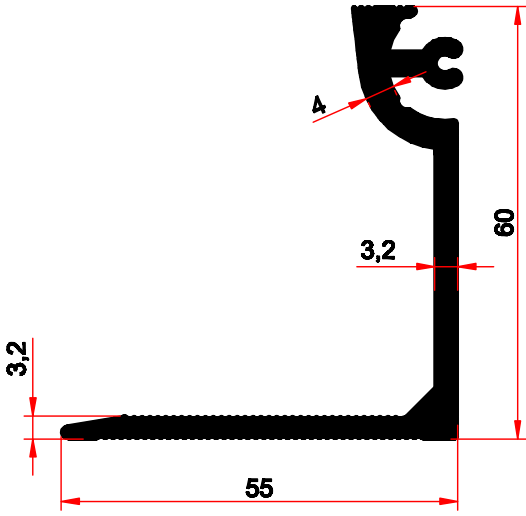

3400
1,201 kg/m

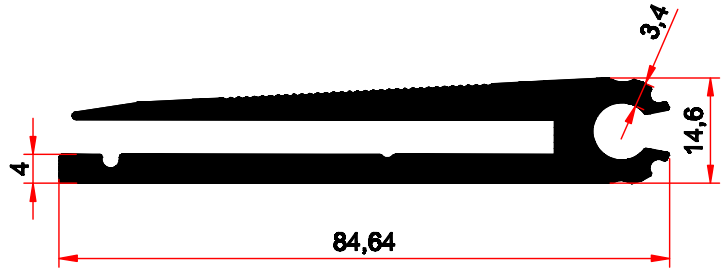

3401
1,765 kg/m

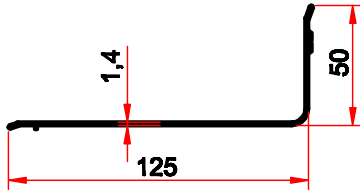

3404
0,689 kg/m

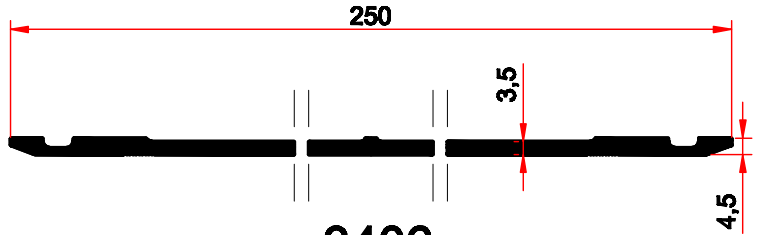

3406
2,417 kg/m

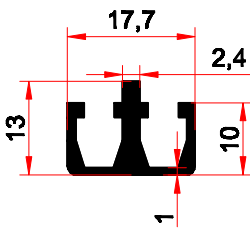

2009-28
0,230 kg/m

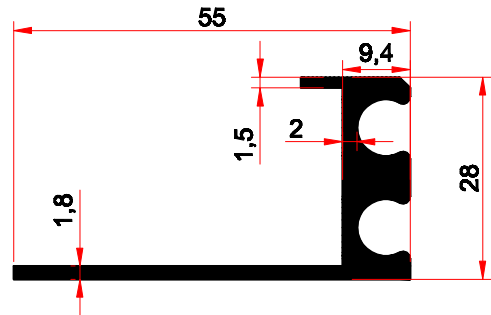

2009-29
0,683 kg/m

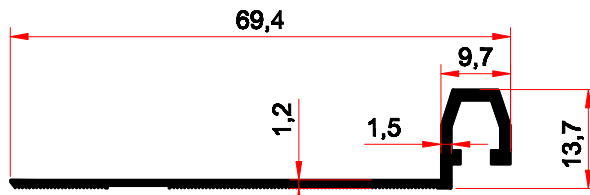

2009-30
0,295 kg/m



ÖZEN ALÜMİNYUM DİLATASYON PROFİLLERİ

