

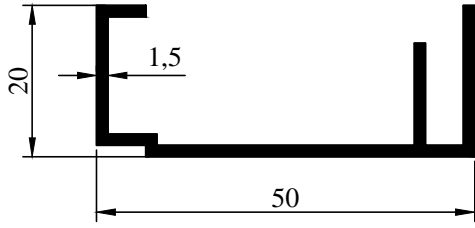

ÖZEN ALÜMİNYUM

REKLAM PROFİLLERİ



85-74  
0,426 kg/m

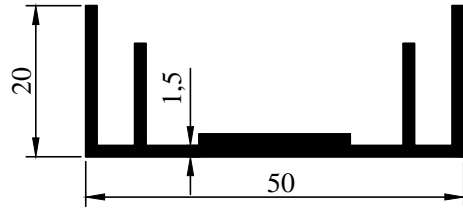

81-12  
0,542 kg/m

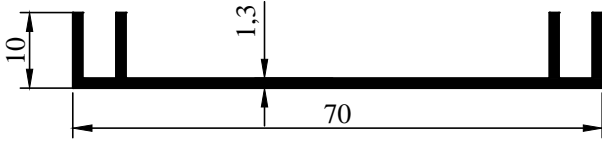

2003-100  
0,367 kg/m

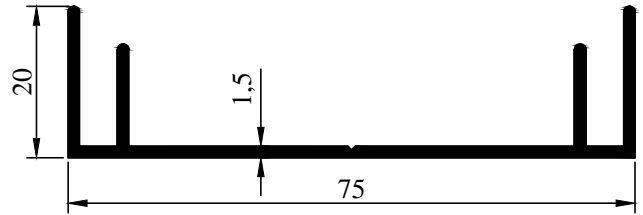

79-84  
0,560 kg/m

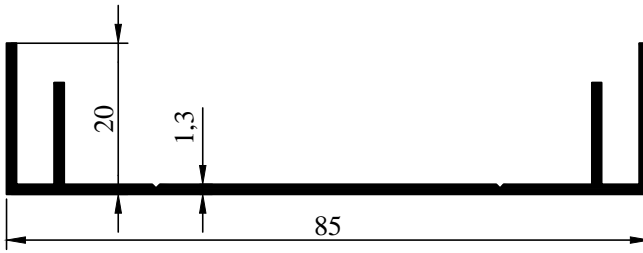

79-113  
0,560 kg/m

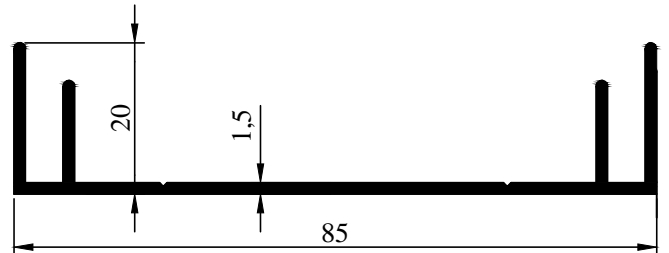

95-13  
0,599 kg/m

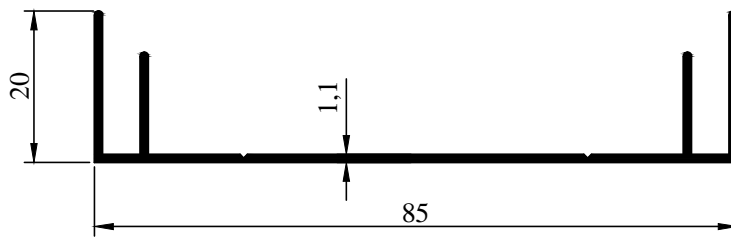

95-18  
0,423 kg/m

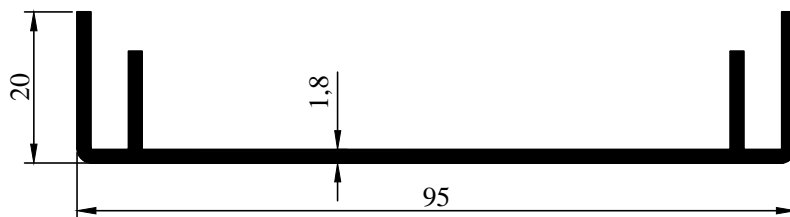

87-88  
0,761 kg/m



ÖZEN ALÜMİNYUM

REKLAM PROFİLLERİ

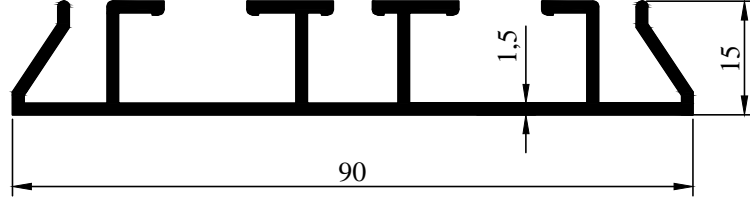

88-34  
0,839 kg/m

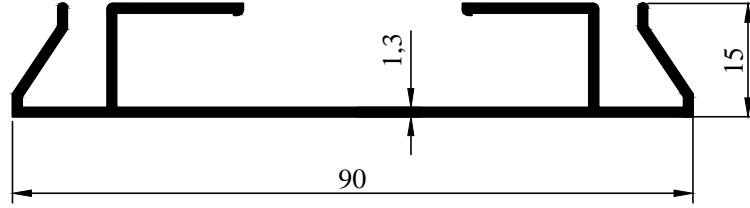

88-81  
0,614 kg/m

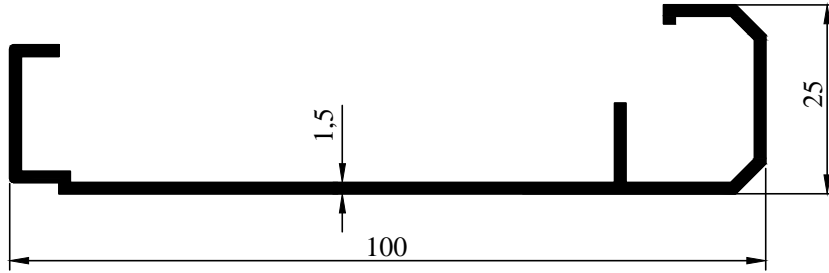

85-65  
0,672 kg/m

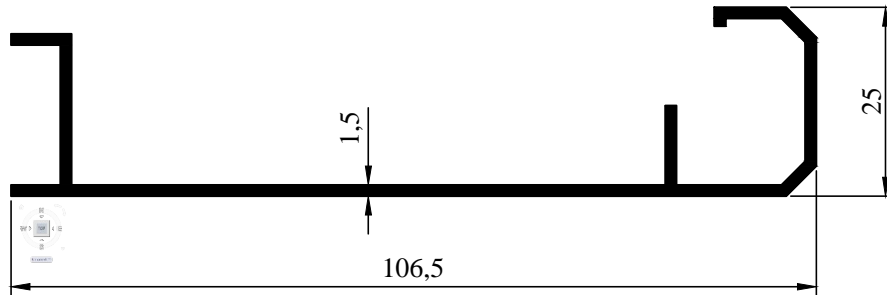

85-66  
0,713 kg/m

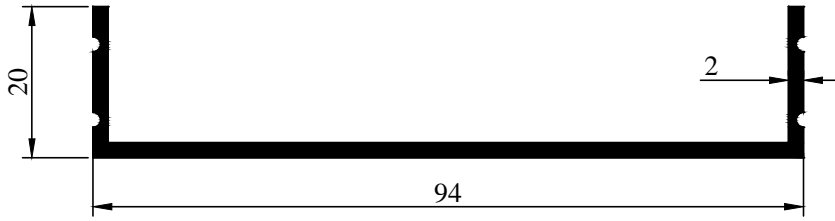
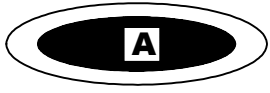

2002-84  
0,719 kg/m

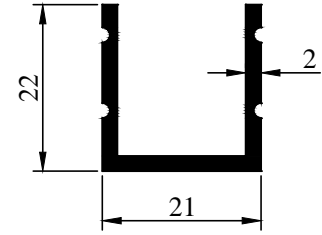

2002-85  
0,346 kg/m

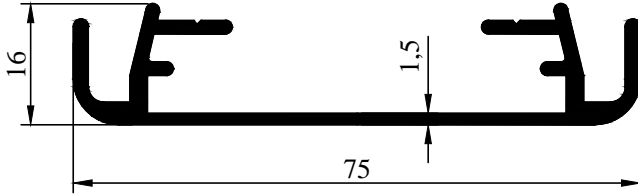

2000-2  
0,727 kg/m

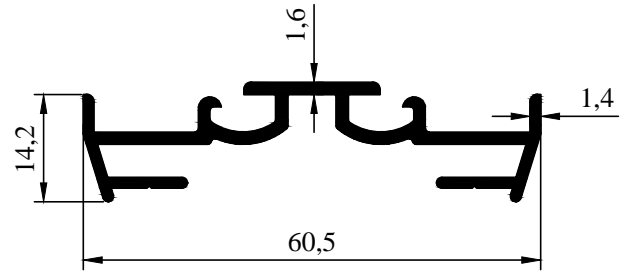

2000-3  
0,559 kg/m

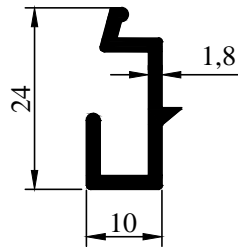

98-59  
0,237 kg/m

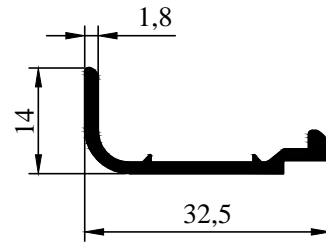

2000-4  
0,203 kg/m

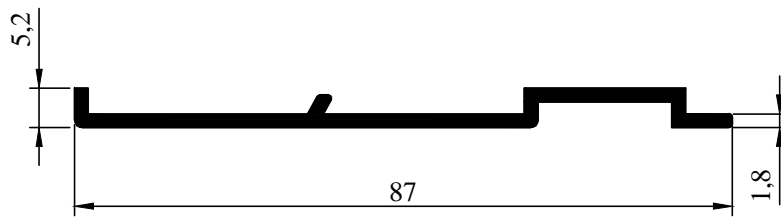

98-57  
0,484 kg/m

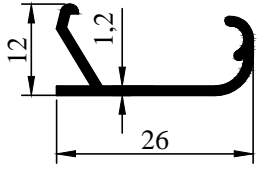

2000-138  
0,158 kg/m

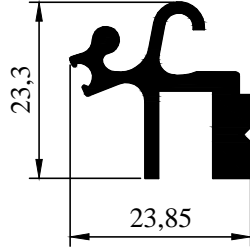

2000-137  
0,441 kg/m

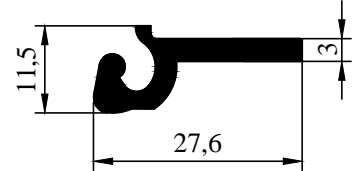

2000-136  
0,310 kg/m

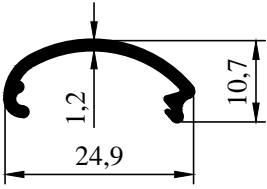

2005-68  
0,128 kg/m

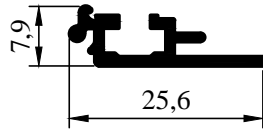

2005-69  
0,160 kg/m

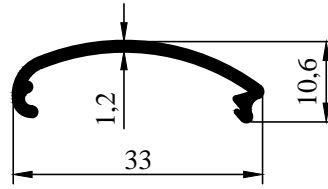

2005-70  
0,151 kg/m

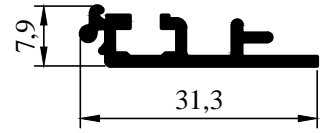

2005-71  
0,193 kg/m

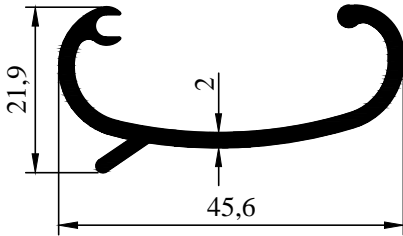

2005-127  
0,453 kg/m

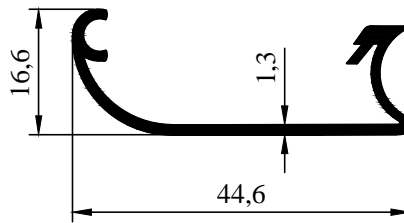

2001-110  
0,160 kg/m

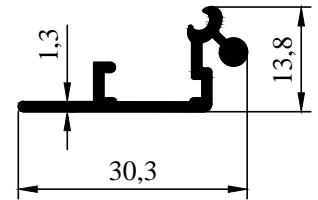

2001-111  
0,207 kg/m

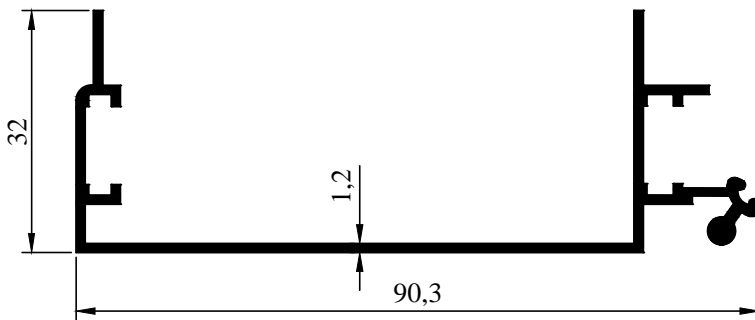

2003-115  
0,626 kg/m

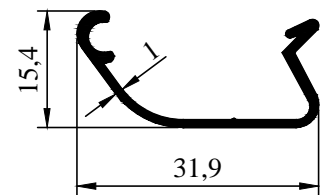

2003-116  
0,184 kg/m

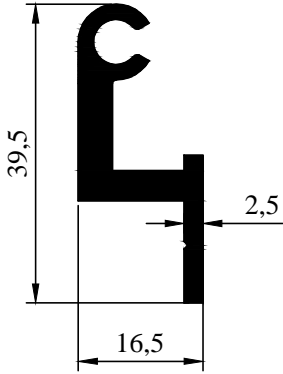

2000-133  
0,555 kg/m

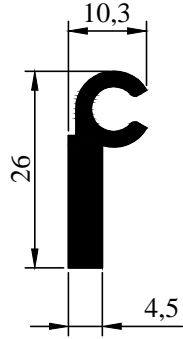

2000-134  
0,325 kg/m

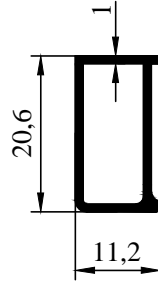

2000-135  
0,162 kg/m

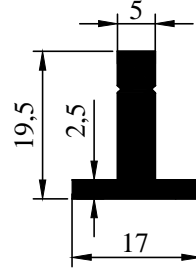

2000-150  
0,343 kg/m

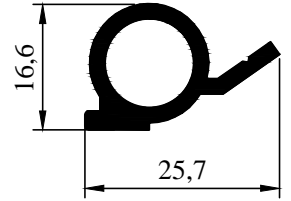

2001-2  
0,340 kg/m

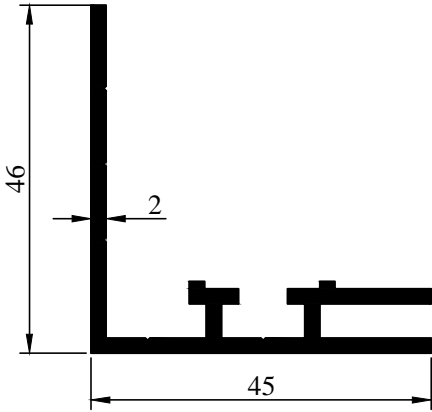

3329  
0,679 kg/m

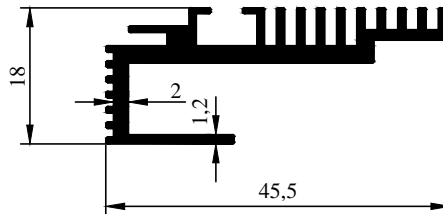

3495  
0,556 kg/m

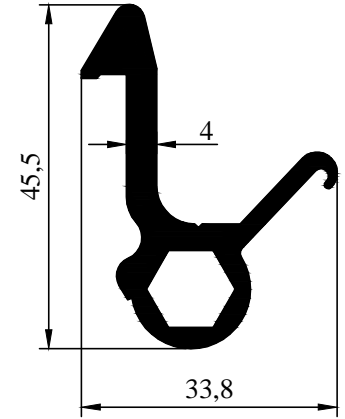

2001-1  
0,874 kg/m

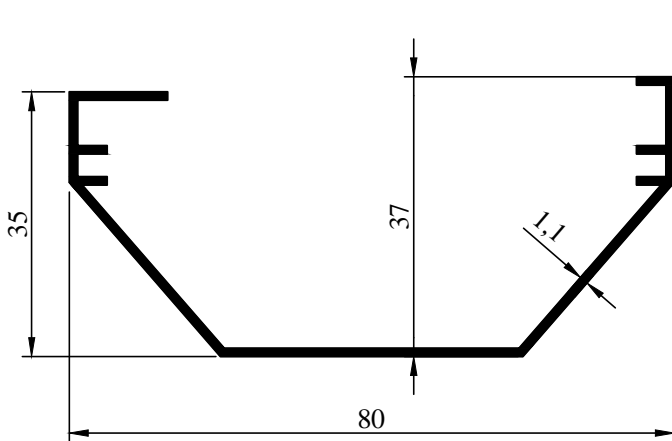

2000-55  
0,464 kg/m

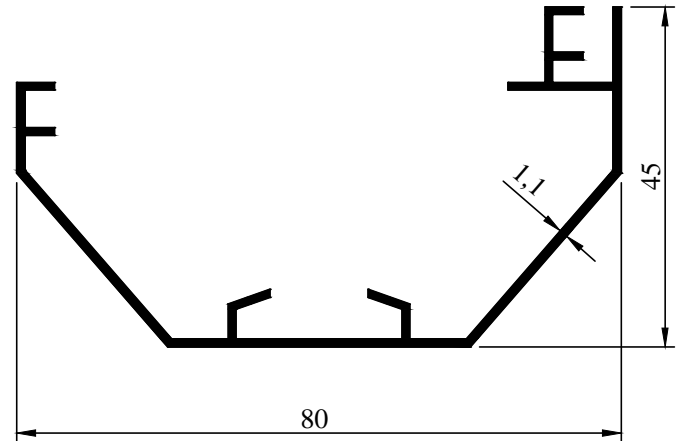

2000-59  
0,554 kg/m



ÖZEN ALÜMİNYUM

REKLAM PROFİLLERİ

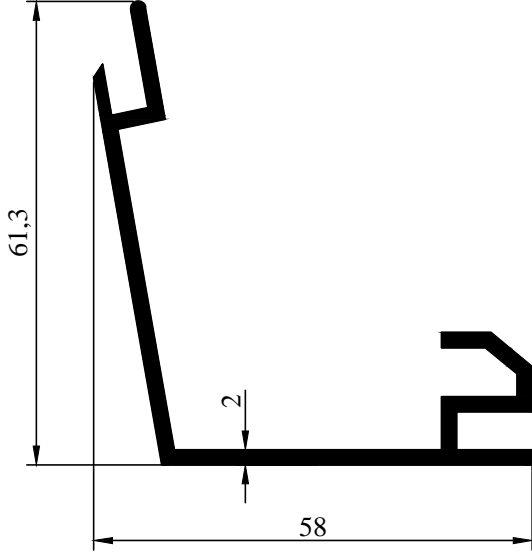

2002-76  
0,813 kg/m

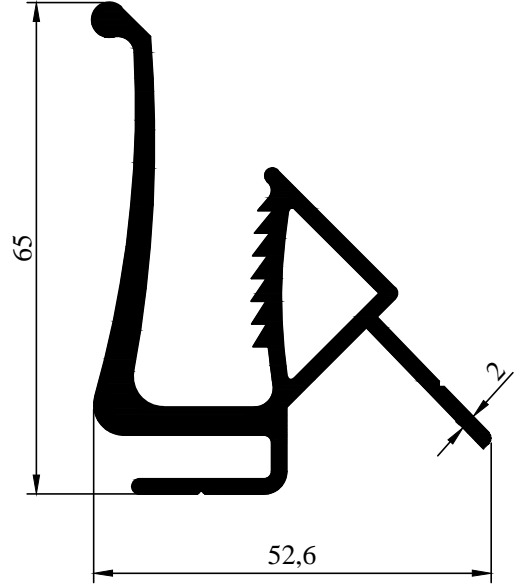

99-14  
1,426 kg/m

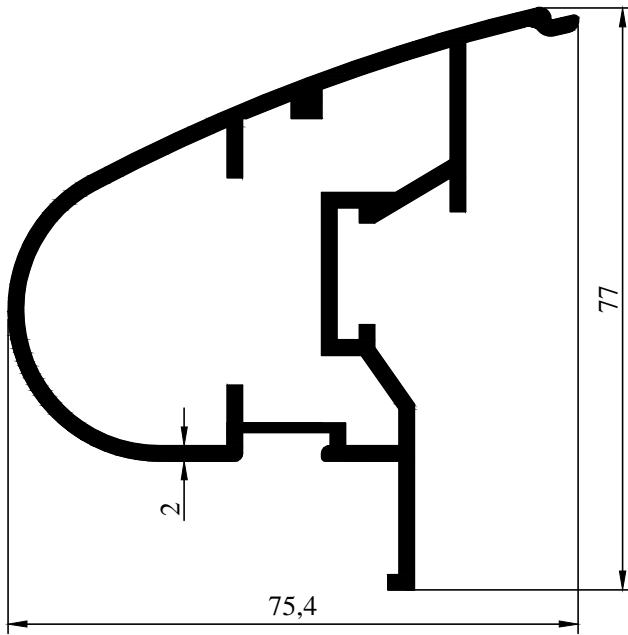

2000-148  
1,496 kg/m

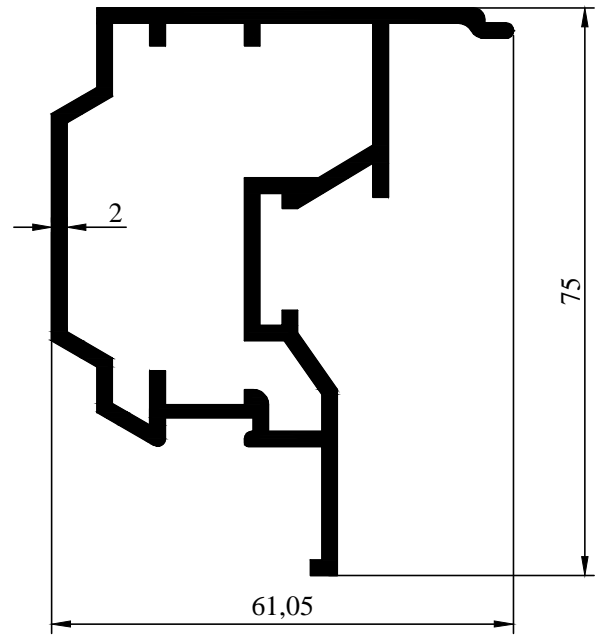

2000-149  
1,450 kg/m



ÖZEN ALÜMİNYUM

REKLAM PROFİLLERİ

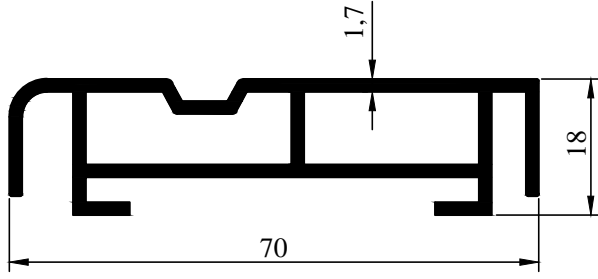

3282  
0.944 kg/m

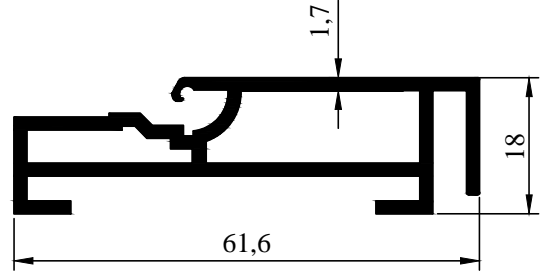

3283  
0.843 kg/m

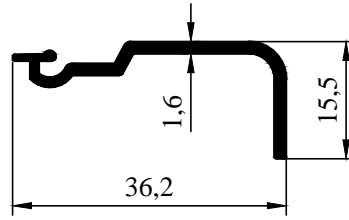

2983  
0,226 kg/m

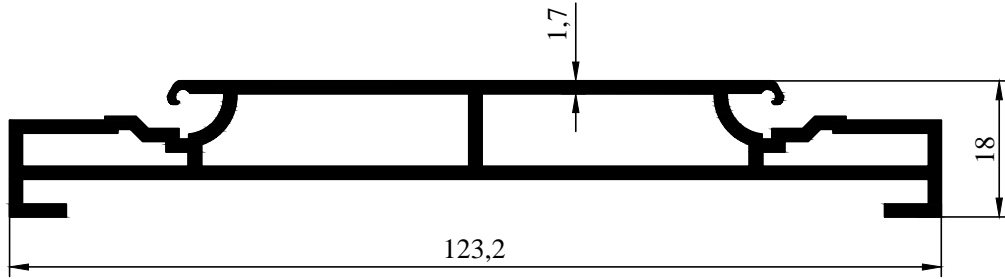

2982  
1,475 kg/m

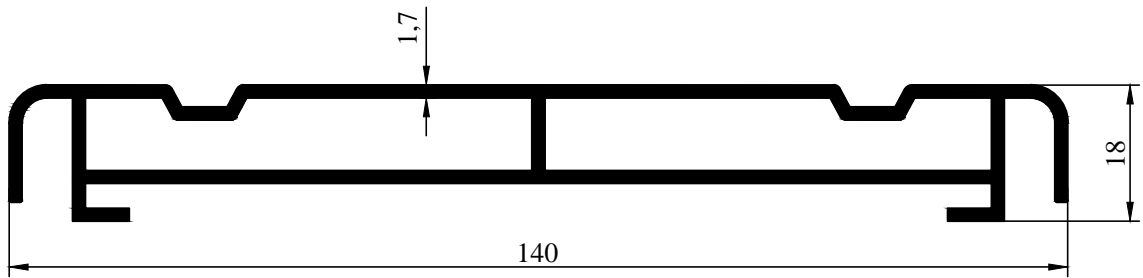

2981  
1,586 kg/m



ÖZEN ALÜMİNYUM

REKLAM PROFİLLERİ

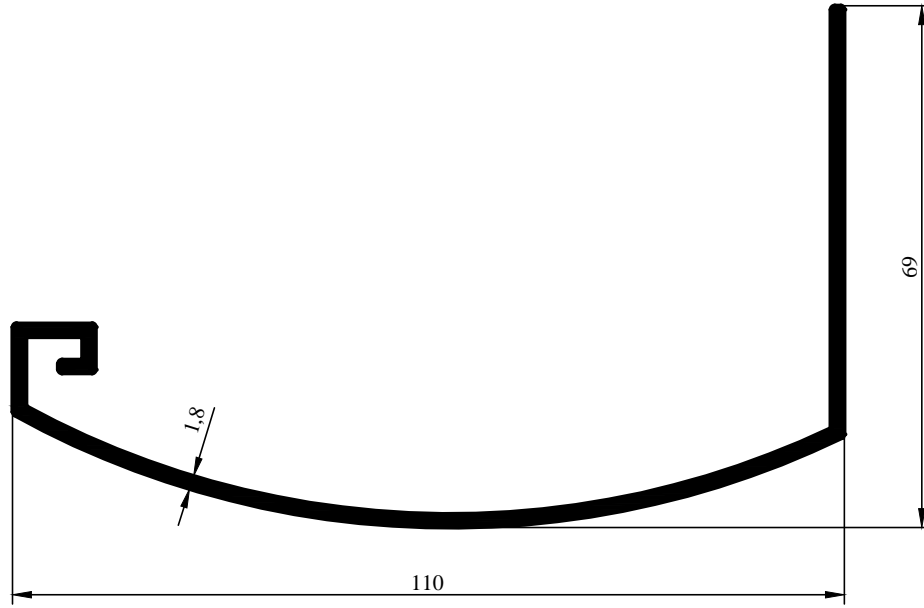

3870  
0,962 kg/m

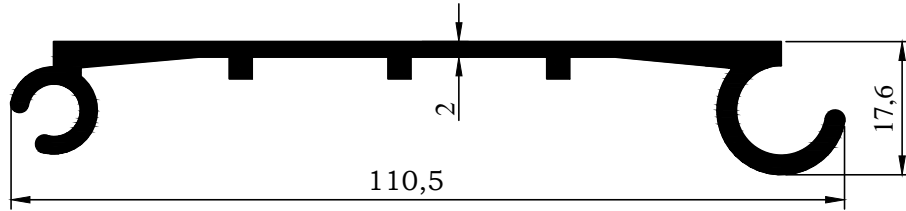

2004-53  
1,042 kg/m

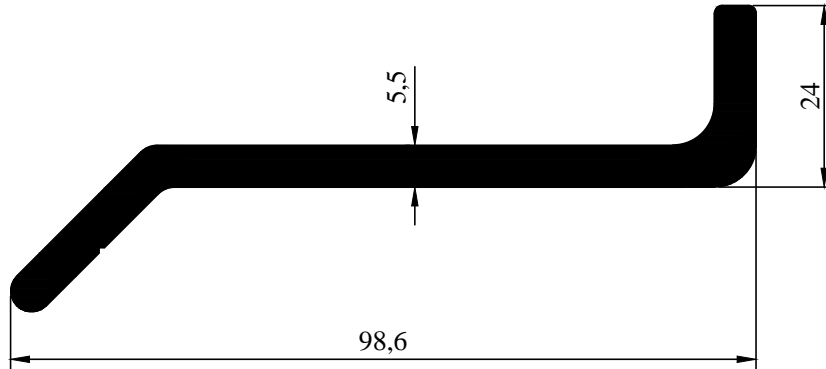

98-58  
1,830 kg/m