

**3526**  
0,505 kg/m

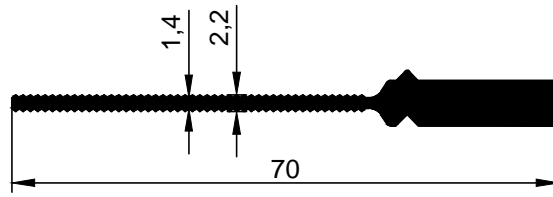

**3086**  
0,539 kg/m

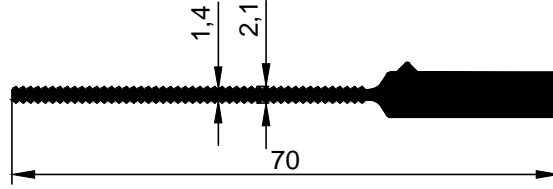

**3527**  
0,573 kg/m

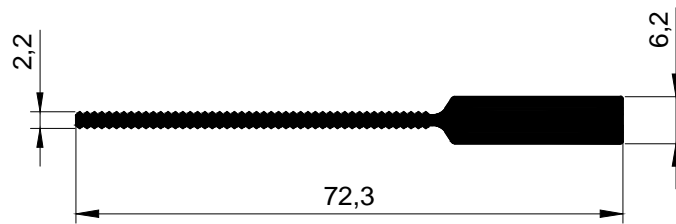

**2946**  
0,628 kg/m

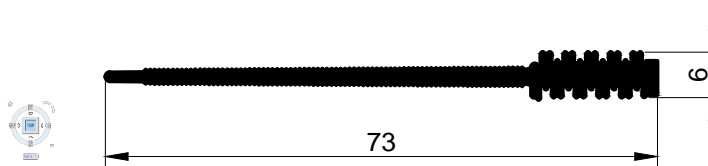

**2008-34-B**  
0.484 kg/m

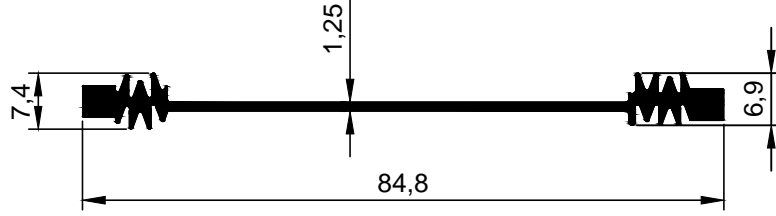

**3655**  
0,477 kg/m

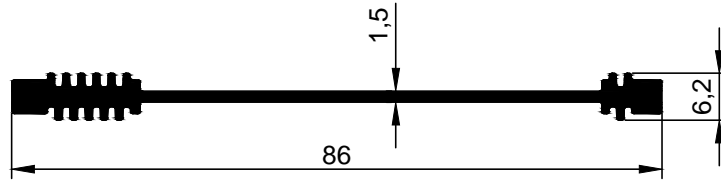

**3660**  
0,550 kg/m

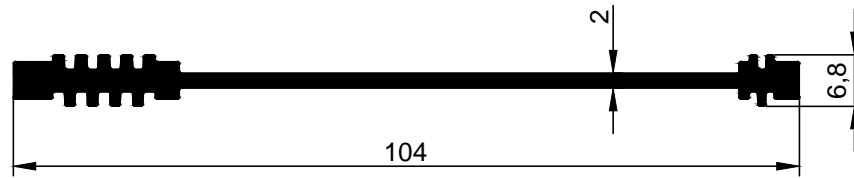

**3670**  
0,803 kg/m

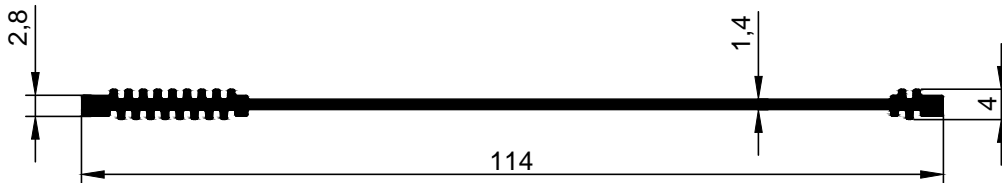

**3671**  
0,540 kg/m

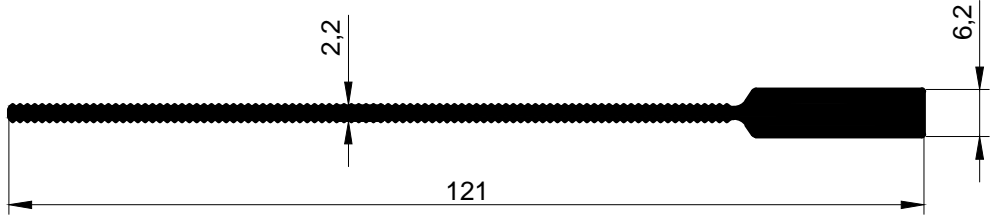

**2914**  
0,866 kg/m

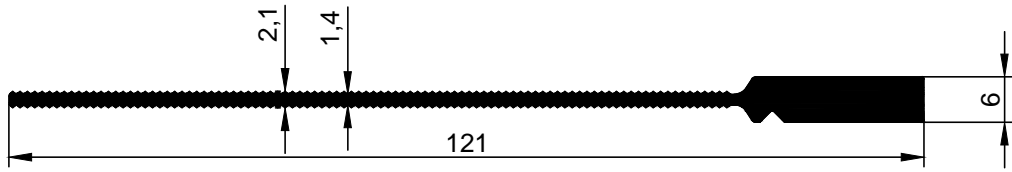

**3544**  
0,752 kg/m

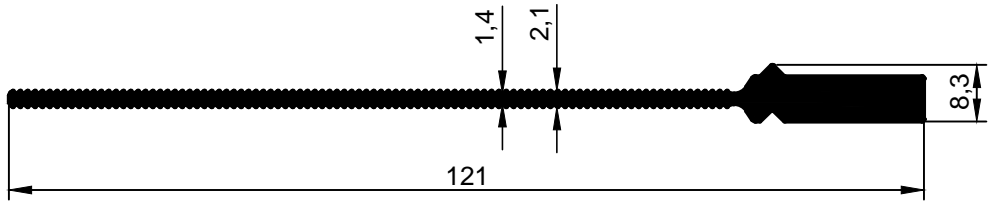

**3085**  
0,786 kg/m

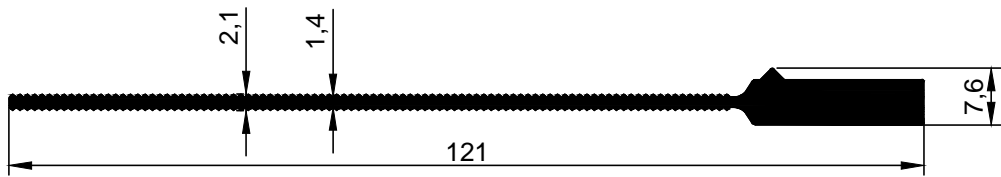

**3545**  
0,821 kg/m

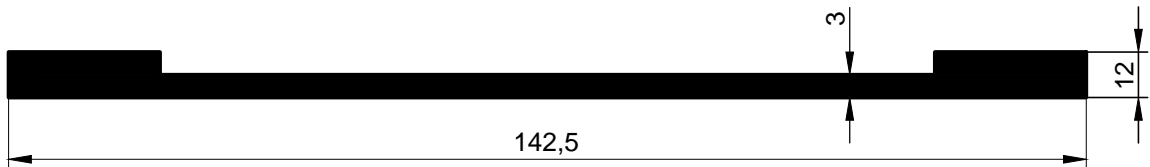

**2008-51-B**  
1.484 kg/m

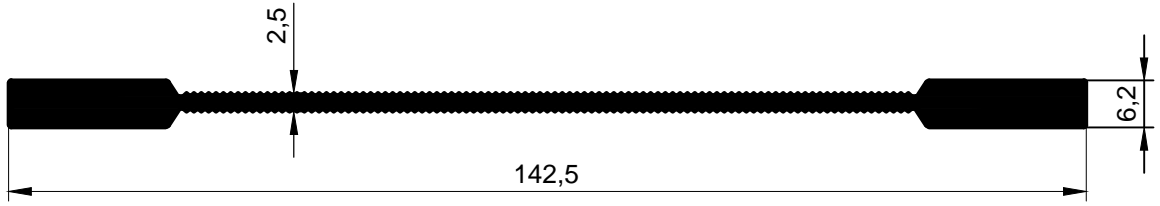

**2008-50-B**  
1,267 kg/m

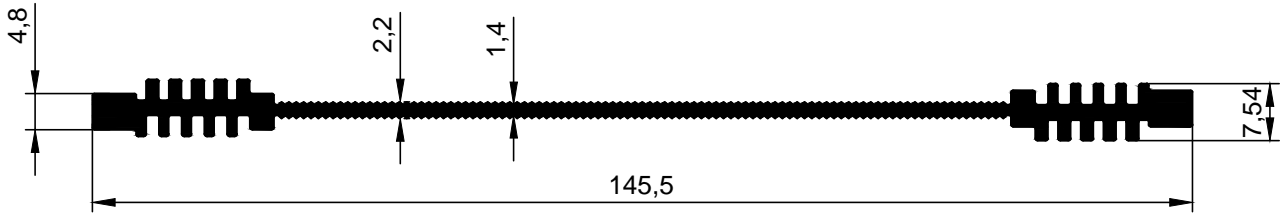

**3672**  
1,089 kg/m

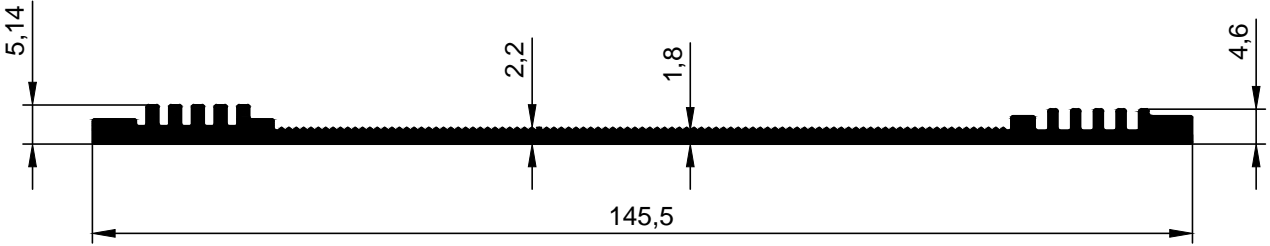

**3680**  
0,978 kg/m

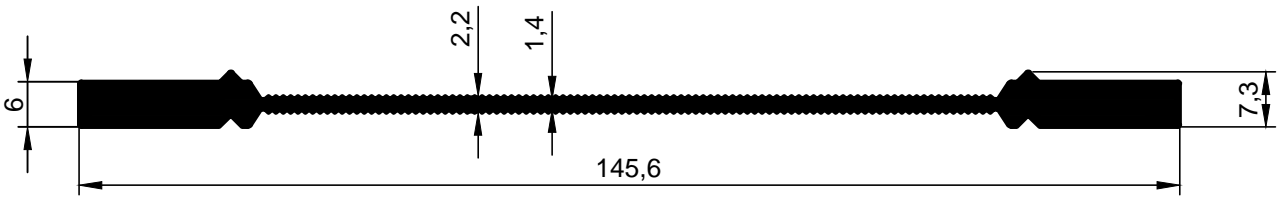

**3076**  
1,237 kg/m

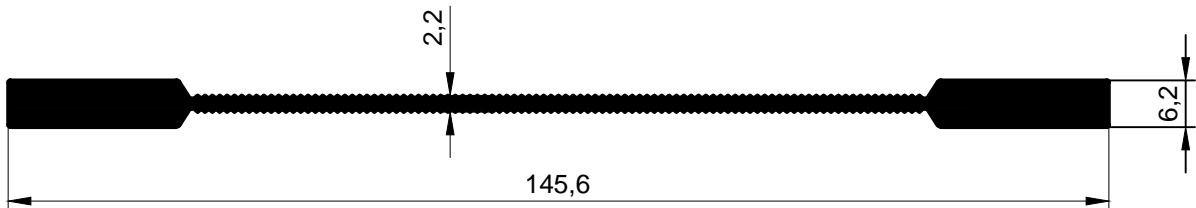

**2969**  
1,262 kg/m

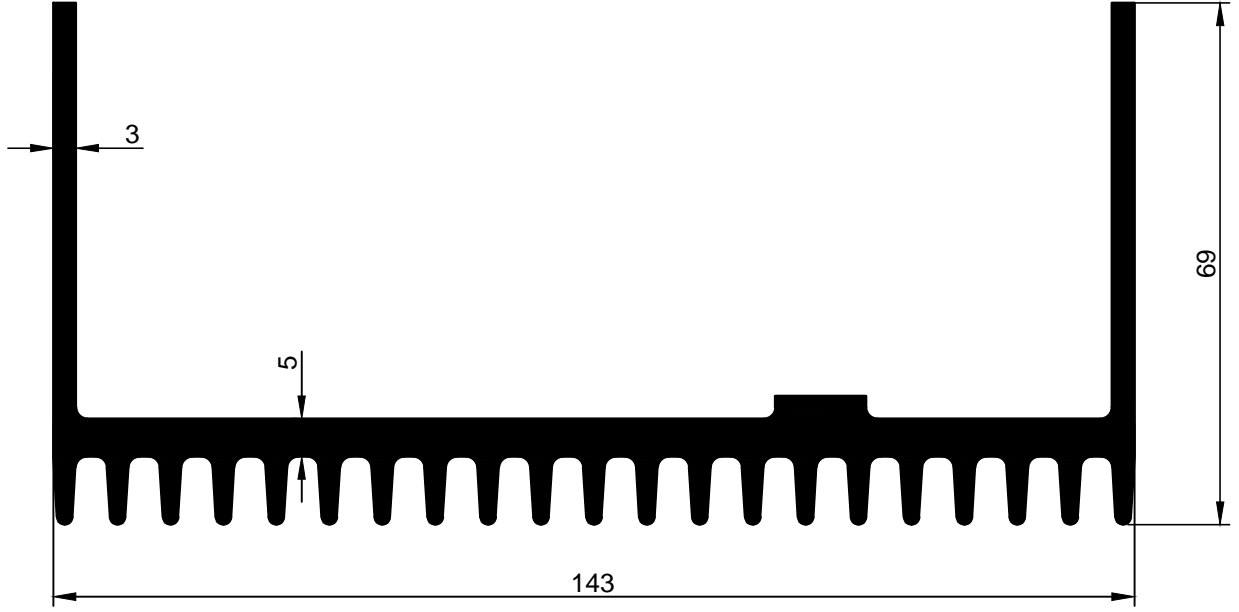

**3220**  
4.207 kg/m

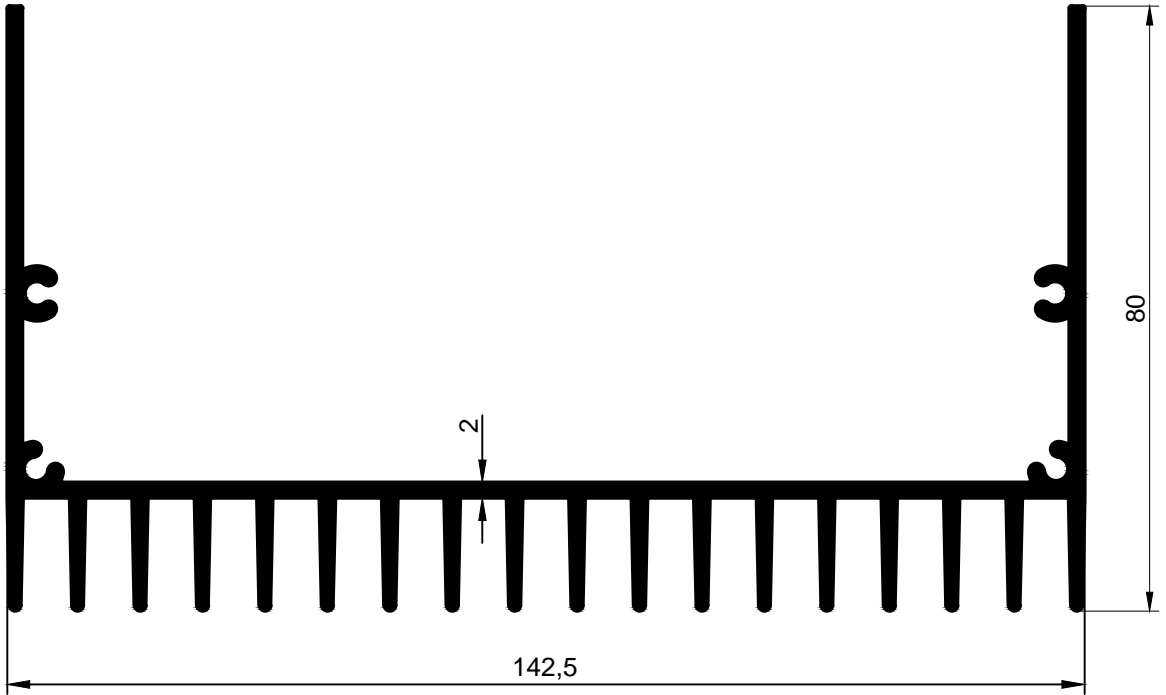

**3080**  
2.916 kg/m

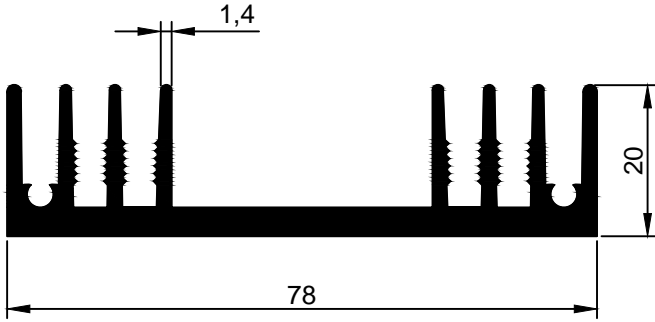

90-2  
1,470 kg/m

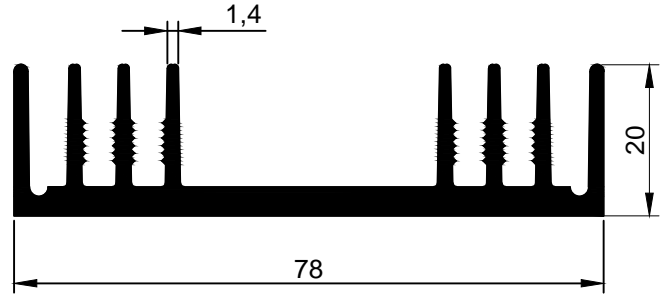

82-47  
1,429 kg/m

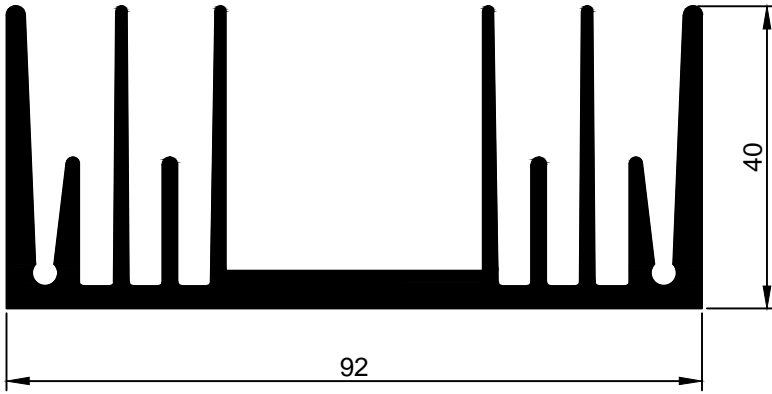

88-54  
2,648 kg/m

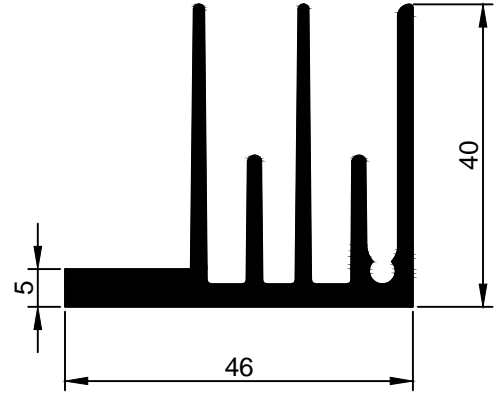

90-1  
1,196 kg/m

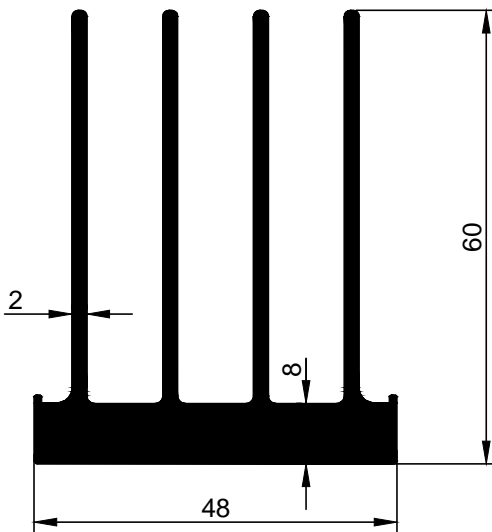

3852  
2,181 kg/m

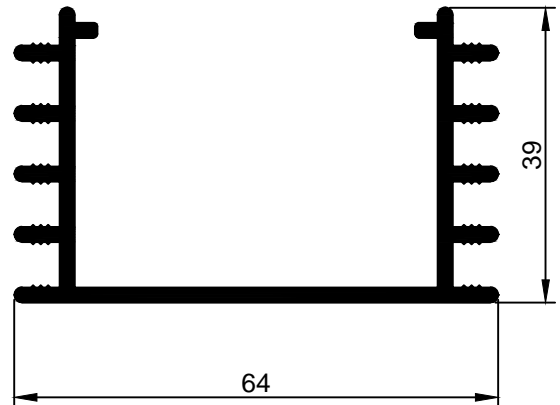

89-72  
1,035 kg/m

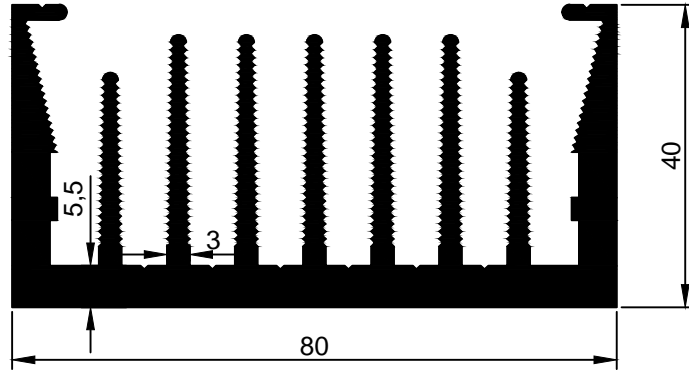

2006-121  
3,465 kg/m

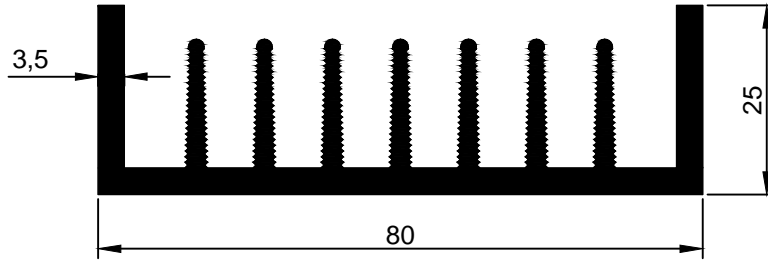

2010-08  
1,853 kg/m

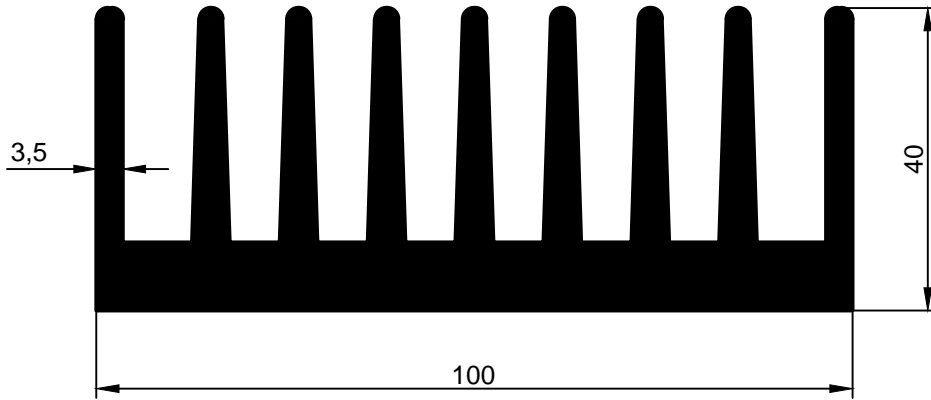

2927  
5,357 kg/m

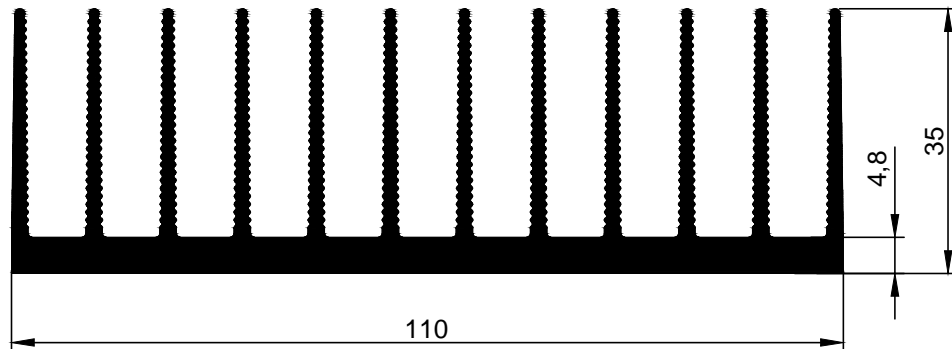

3818  
3,058 kg/m

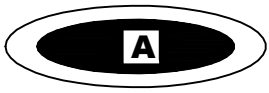

ÖZEN ALÜMİNYUM SOĞUTUCU PROFİLLERİ

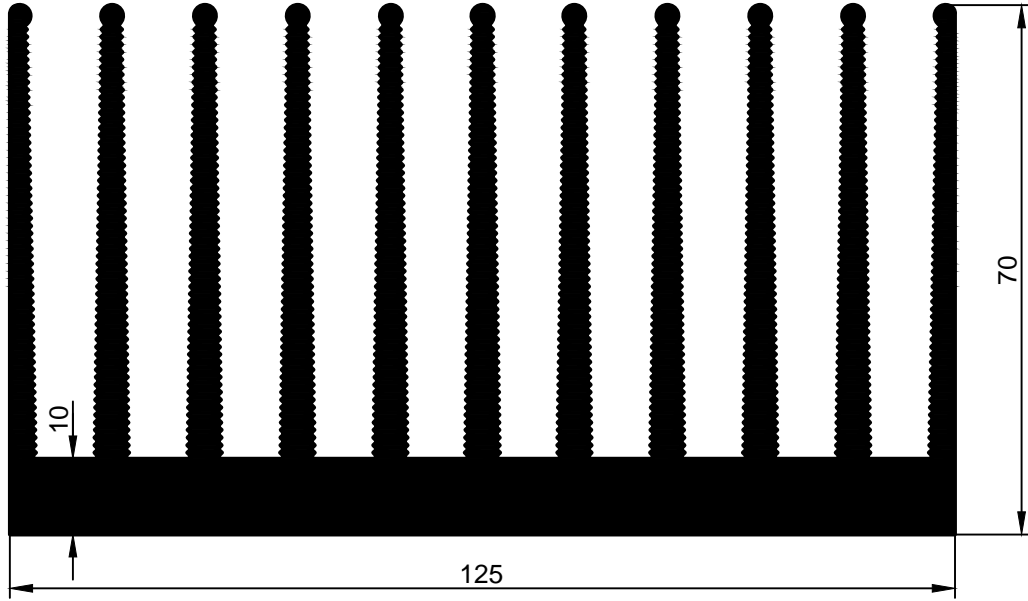

2906  
8,552 kg/m

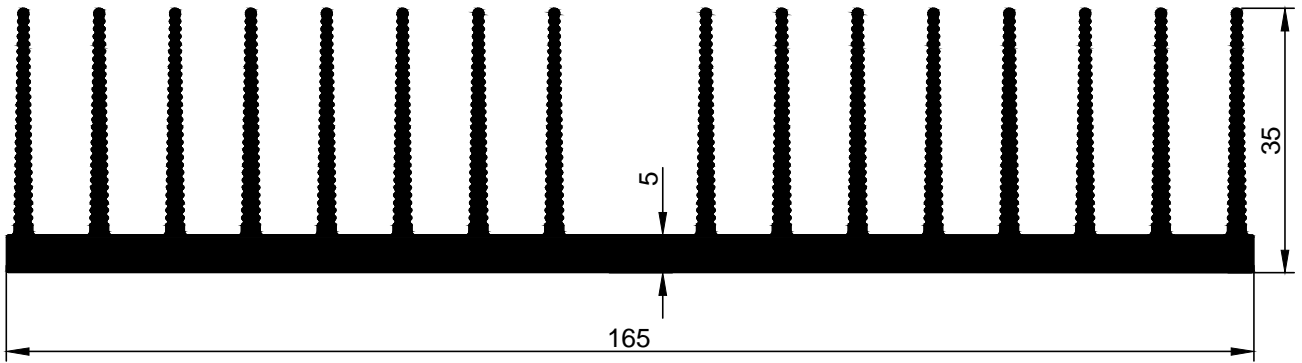

3819  
4,549 kg/m

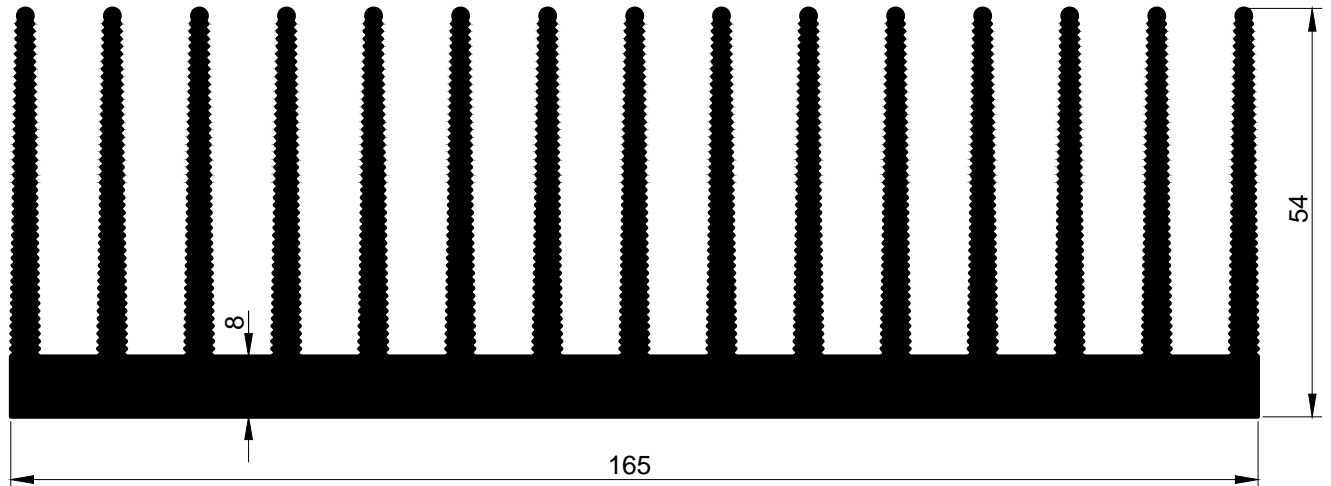

3018  
8,245 kg/m

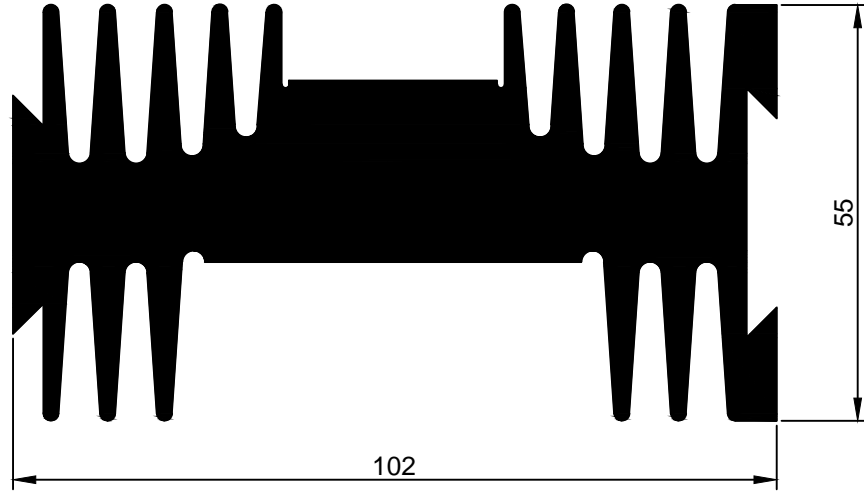

88-11  
7,443 kg/m

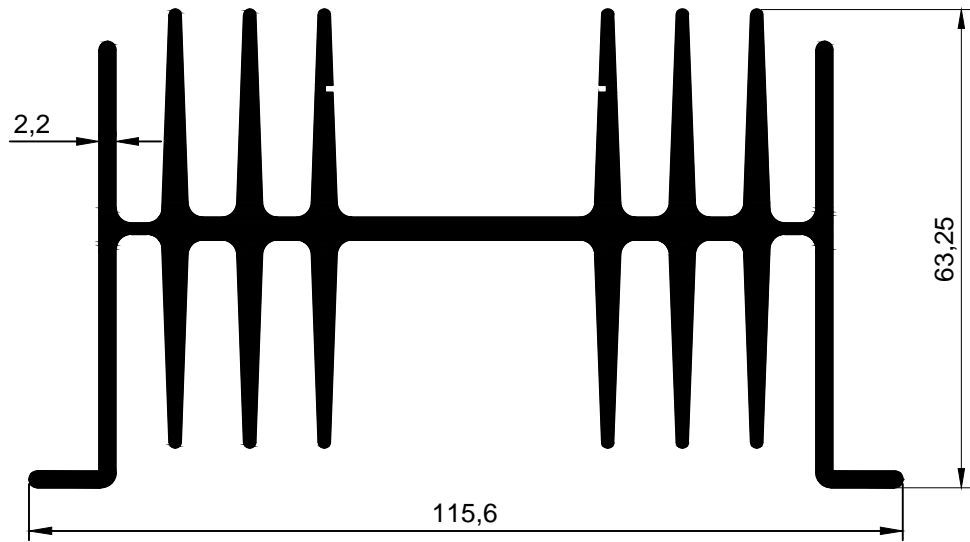

3021  
3,791 kg/m

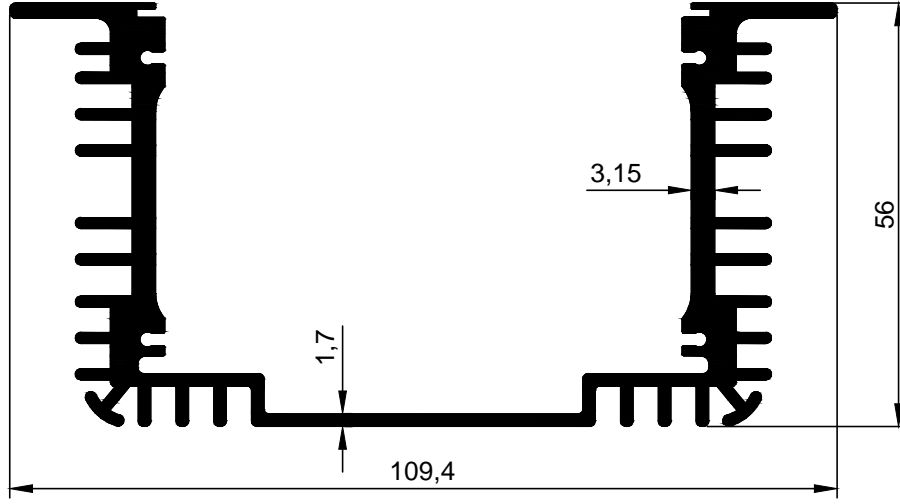

**3429**  
2,383 kg/m

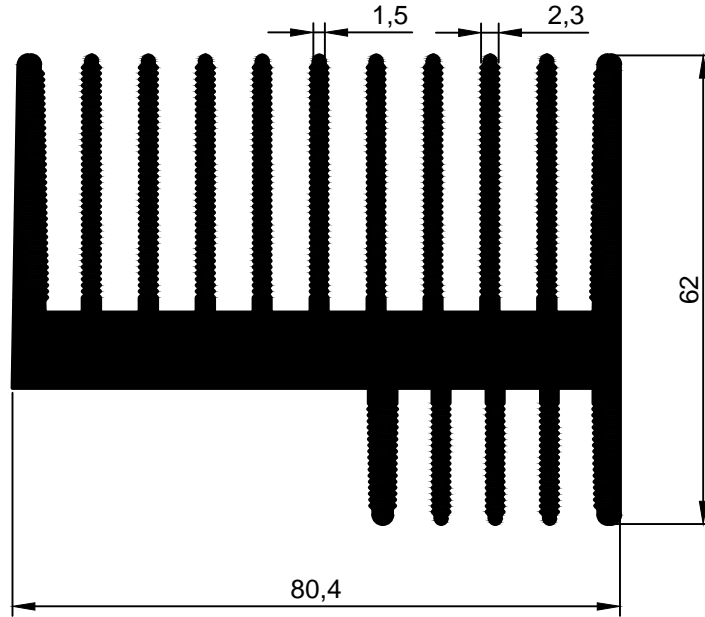

**3242**  
4,984 kg/m

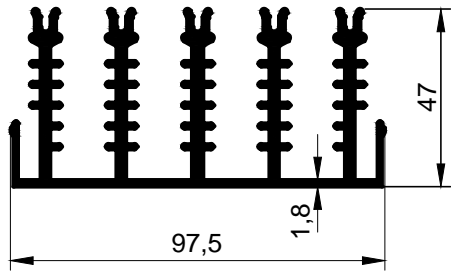

**2970**  
2,987 kg/m

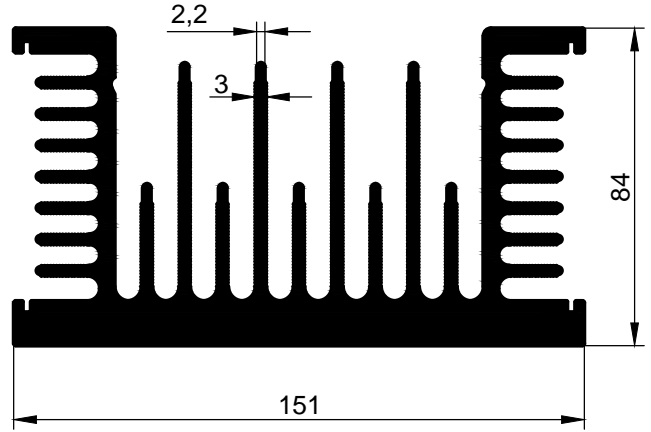

**2971**  
11,837 kg/m

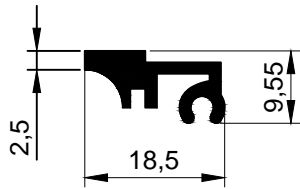

**2006-123**  
0,223 kg/m

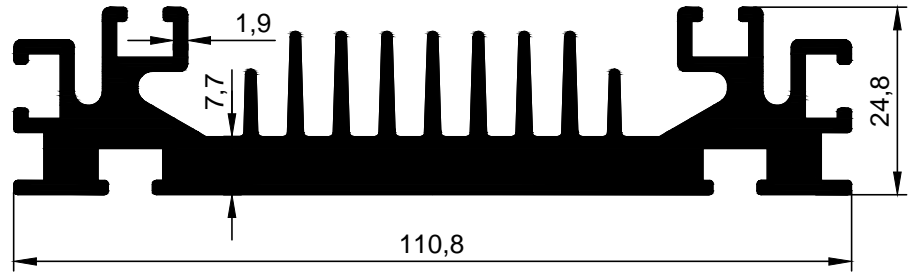

**2014-121**  
3,483 kg/m

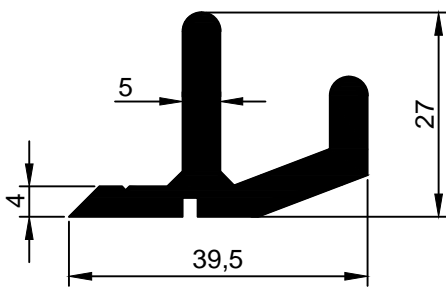

**2006-122**  
0,876 kg/m

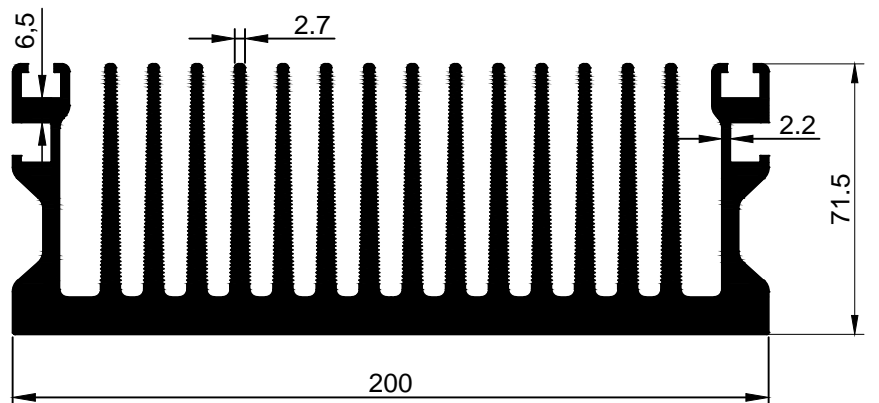

**2972**  
16,053 kg/m

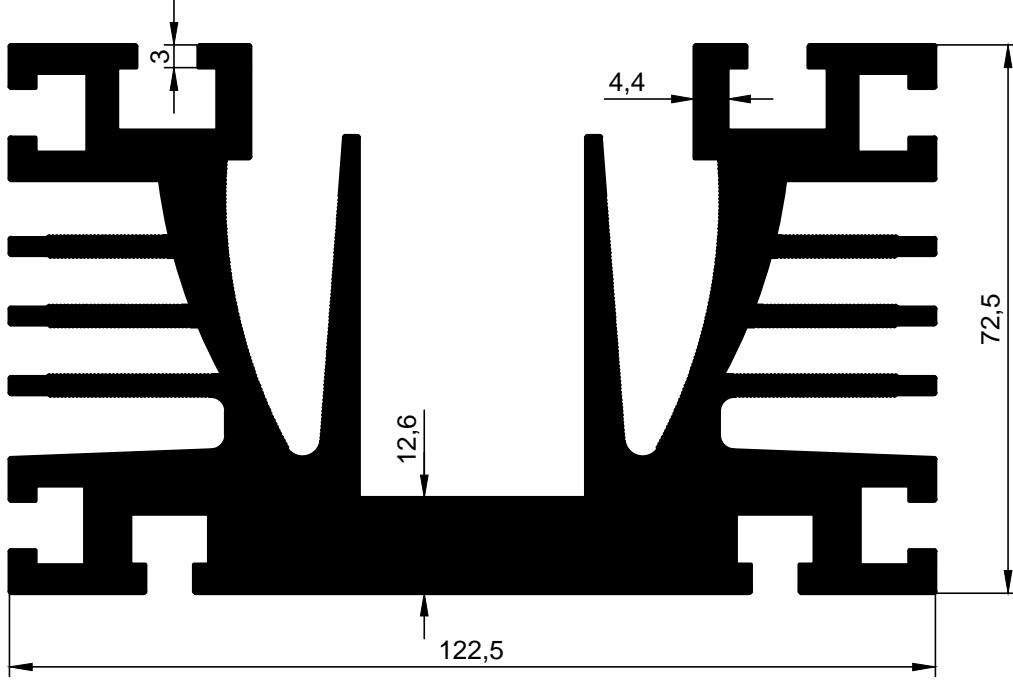

**2974**  
9,524 kg/m

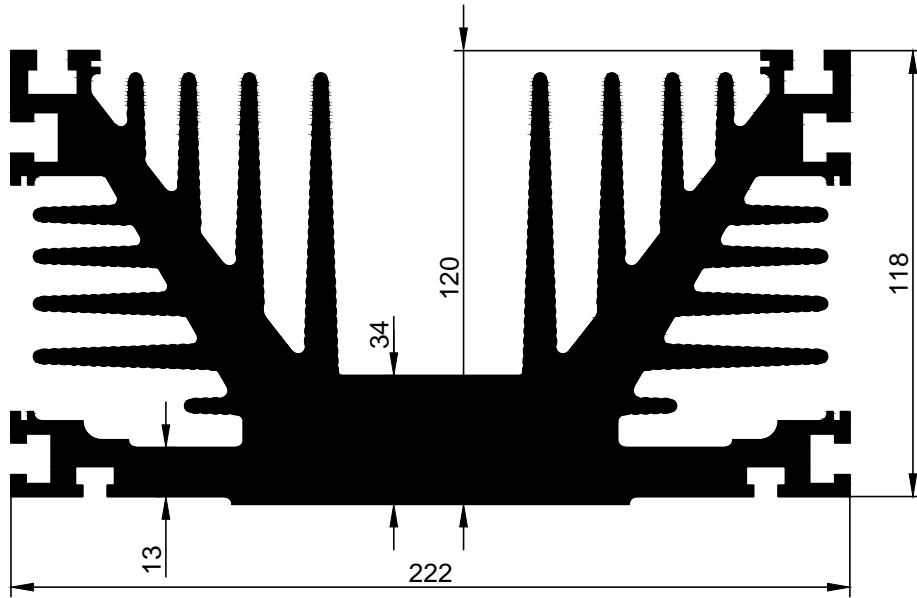

**3816**  
32,151 kg/m

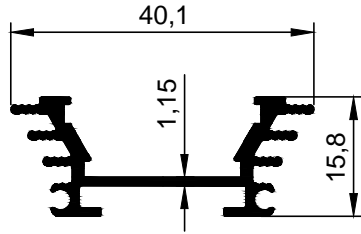

**2014-117**  
0,349 kg/m

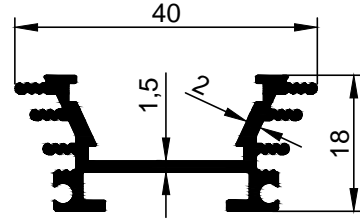

**3817**  
0,437 kg/m

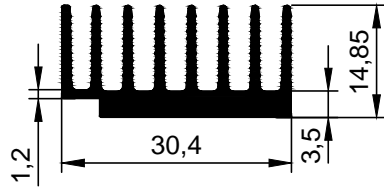

**3947**  
0,549 kg/m

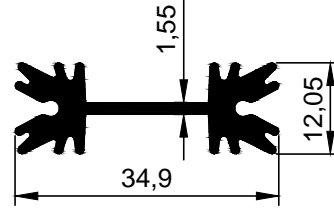

**3959**  
0,465 kg/m

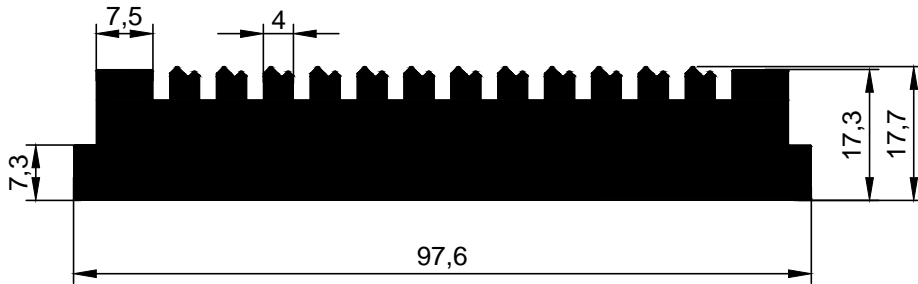

**3830**  
4,066 kg/m

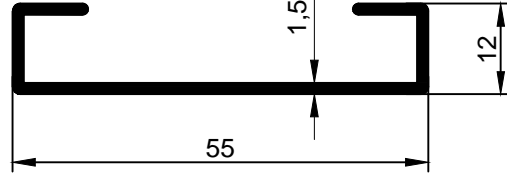

2926  
0,374 kg/m

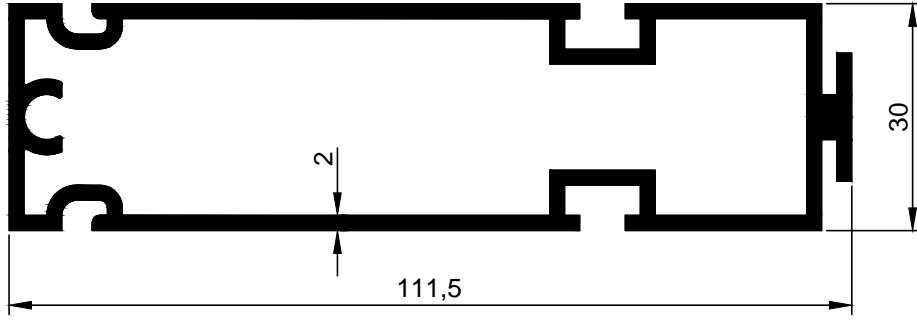

3188  
1.890 kg/m

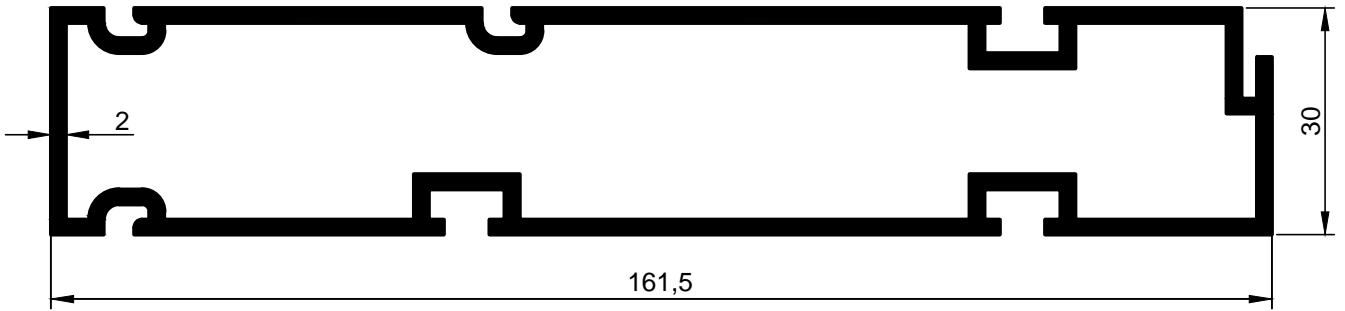

3187  
2.449 kg/m