

3019  
0,557 kg/m

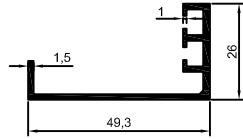

3224  
0,444 kg/m

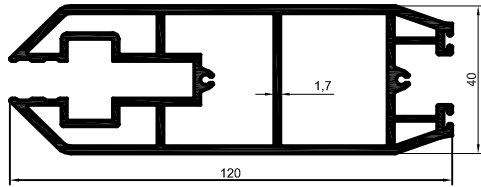

3038  
2,558 kg/m

1

4.01 L.03 REV:0 12.01.2012  
REV:001.10.2015

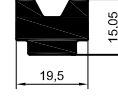

3000  
0,631 kg/m

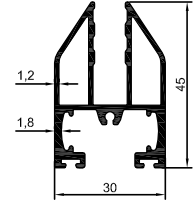

2967  
0,828 kg/m

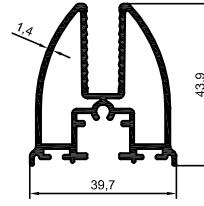

4220  
0,899 kg/m

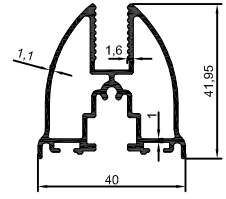

3884  
0,740 kg/m

2

4.01 L.03 REV:0 12.01.2012  
REV:2 05.01.2017

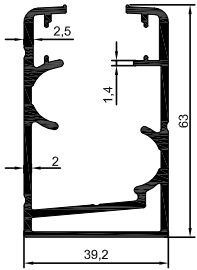

3885  
1,359 kg/m

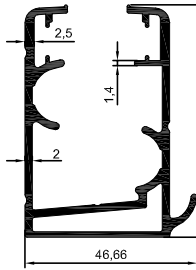

3886  
1,416 kg/m

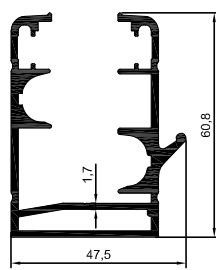

4139  
1,475 kg/m

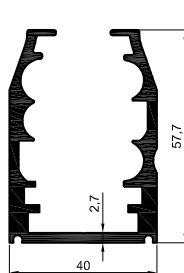

2968  
1,480 kg/m

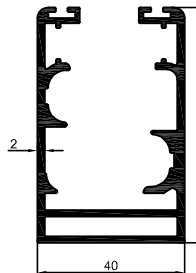

4211  
1,475 kg/m

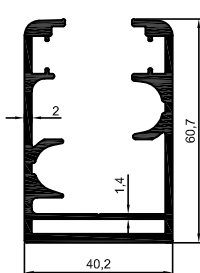

4218  
1,475 kg/m

3

4.01 L.03 REV:0 12.01.2012  
REV:1 05.01.2017

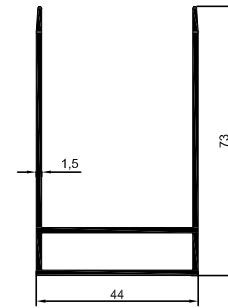

4141  
0,916 kg/m

4

4.01 L.03 REV:0 12.01.2012  
REV:0 07.10.2015

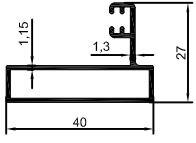

3883  
0,409 kg/m

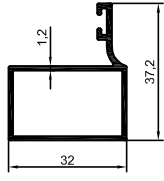

4217  
0,423 kg/m

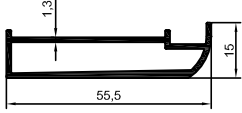

4212  
0,525 kg/m

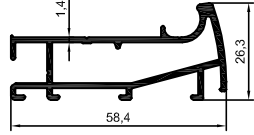

4219  
0,731 kg/m

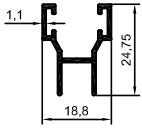

4180  
0,223 kg/m

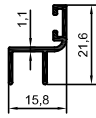

4181  
0,155 kg/m

5

4.01 L.03 REV:0 12.01.2012  
REV:005.01.2017

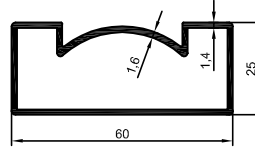

4295  
0,710 kg/m

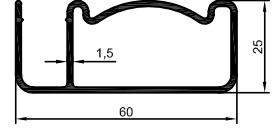

4296  
0,719 kg/m

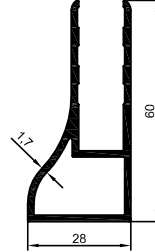

4297  
0,815 kg/m

6

4.01 L.03 REV:0 12.01.2012  
REV:1 23.05.2017

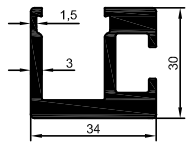

4541  
1,136 kg/m

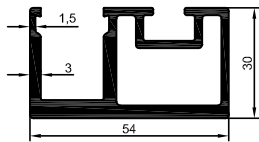

4542  
1,435 kg/m

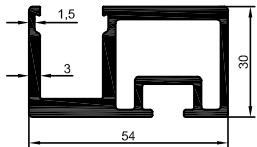

4543  
1,435 kg/m

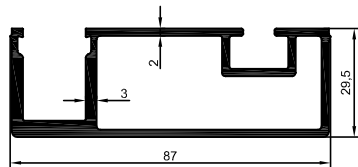

4547  
1,631 kg/m

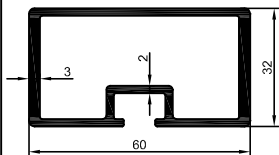

4549  
1,228 kg/m

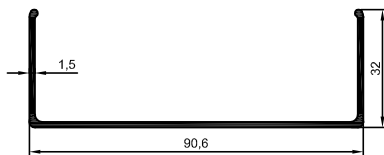

4550  
0,622 kg/m

7

4.01 L.03 REV:0 12.01.2012  
REV:1 24.04.2019

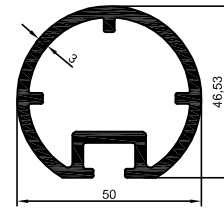

4548  
1,476 kg/m

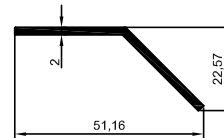

4646  
0,321 kg/m

8

4.01 L.03 REV:0 12.01.2012  
REV:2 22.07.2019

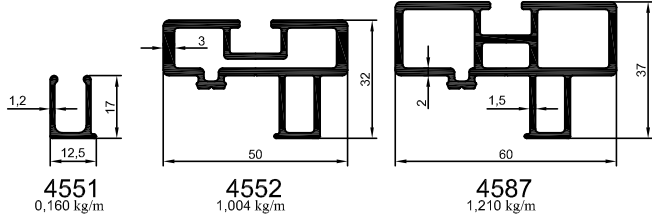

9

4.01 L.03 REV:0 12.01.2012  
REV:1 24.04.2019

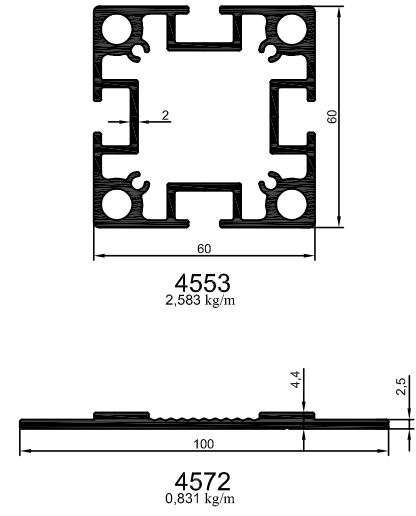

10

4.01 L.03 REV:0 12.01.2012  
REV:0 24.04.2019

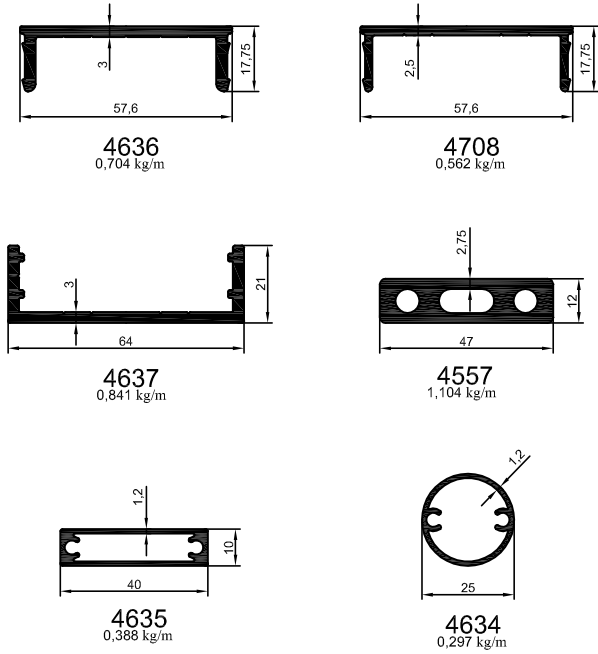

11

4.01 L.03 REV:0 12.01.2012  
REV:1 13.12.2019

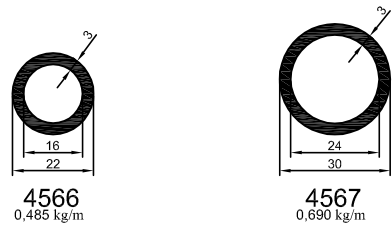

12

4.01 L.03 REV:0 12.01.2012  
REV:0 24.04.2019

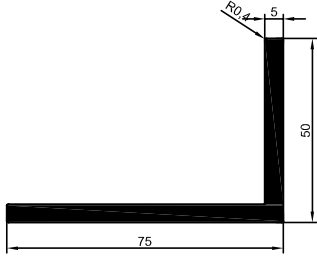

4582  
1,626 kg/m

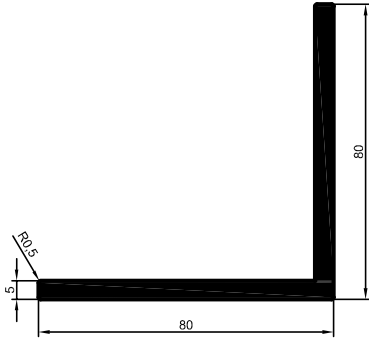

4583  
2,100 kg/m

13

4.01 L.03 REV:0 12.01.2012  
REV:1 02.04.2019

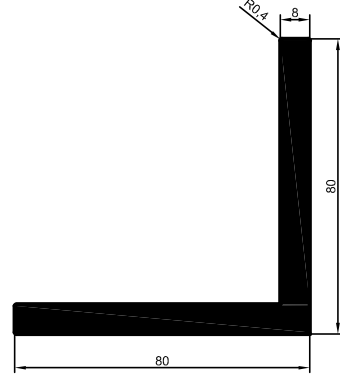

4676  
3,295 kg/m

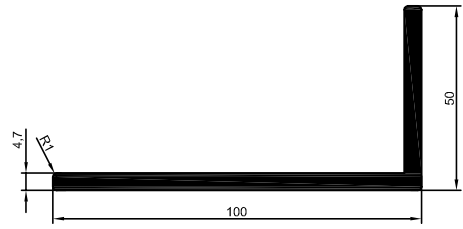

4555  
1,848 kg/m

14

4.01 L.03 REV:0 12.01.2012  
REV:1 10.10.2019

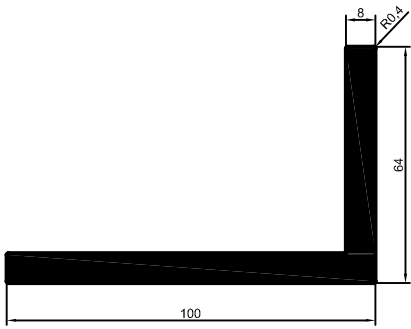

4677  
3,382 kg/m

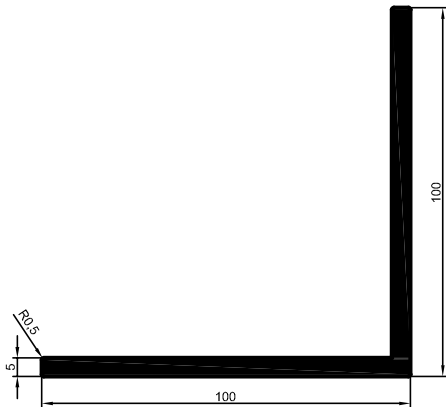

4584  
2,642 kg/m

15

4.01 L.03 REV:0 12.01.2012  
REV:1 10.10.2019

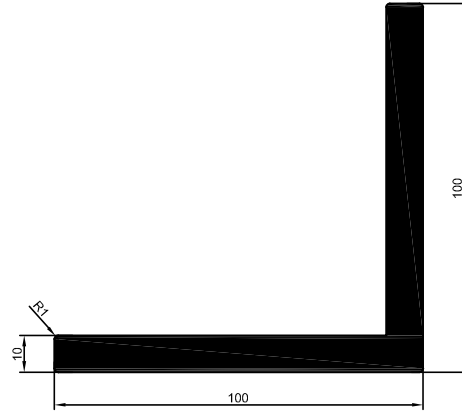

4556  
5,146 kg/m

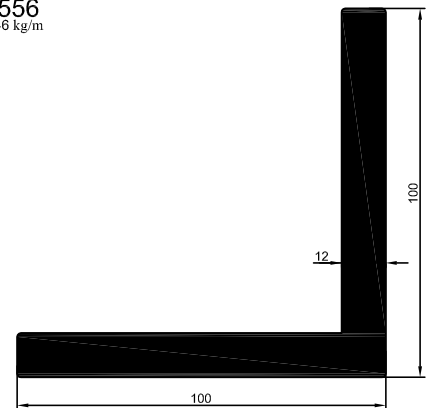

4554  
6,111 kg/m

16

4.01 L.03 REV:0 12.01.2012  
REV:1 10.10.2019

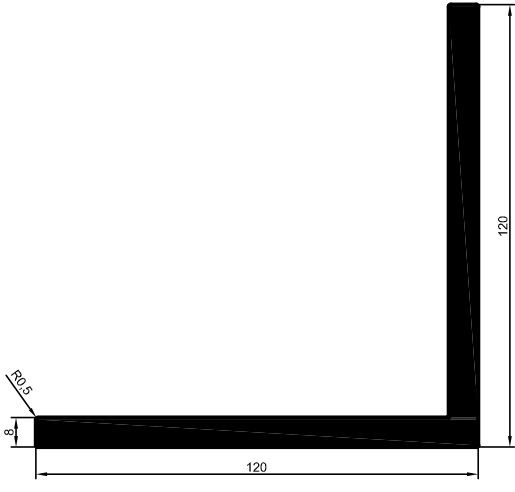

4585  
5,029 kg/m

17

4.01 L.03 REV:0 12.01.2012  
REV:1 10.10.2019

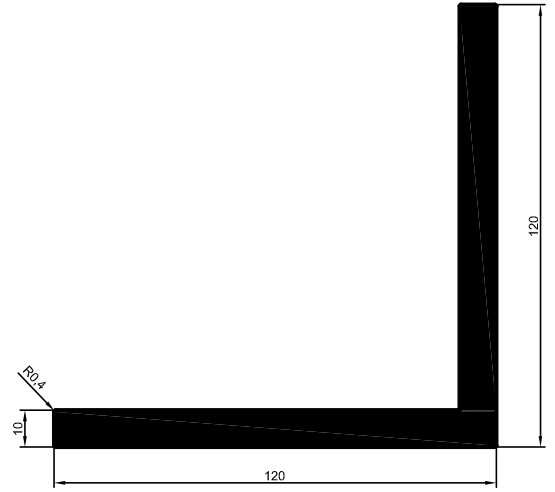

4678  
6,233 kg/m

18

4.01 L.03 REV:0 12.01.2012  
REV:1 10.10.2019

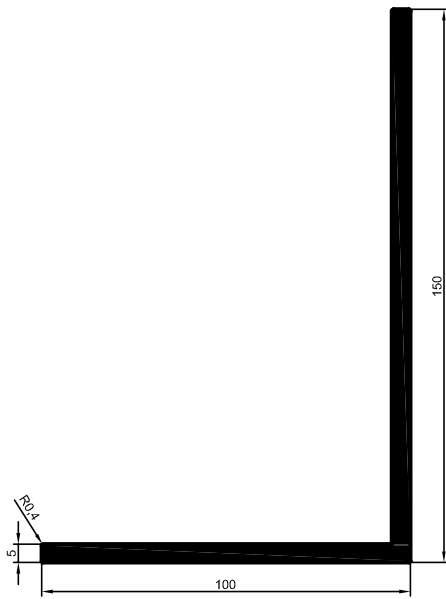

4568  
3,319 kg/m

19

4.01 L.03 REV:0 12.01.2012  
REV:1 10.10.2019

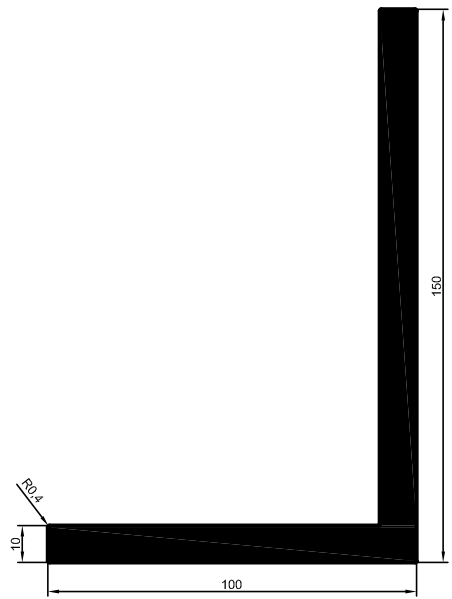

4655  
6,504 kg/m

20

4.01 L.03 REV:0 12.01.2012  
REV:1 10.10.2019

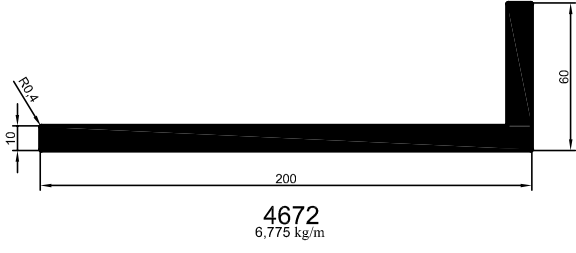

21

4.01 L.03 REV:0 12.01.2012  
REV:0 10.10.2019



22



23



24

4.01 L.03 REV:0 12.01.2012  
REV:0 10.10.2019

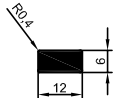

4577  
0,195 kg/m

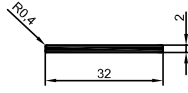

4670  
0,173 kg/m

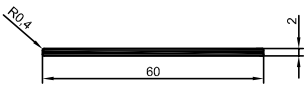

4673  
0,325 kg/m

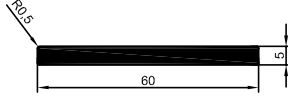

4586  
0,812 kg/m

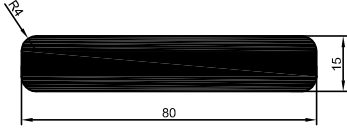

4540  
3,215 kg/m

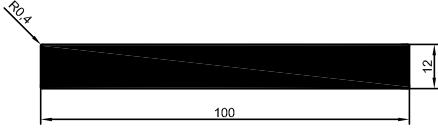

4565  
3,252 kg/m

25

4.01 L.03 REV:0 12.01.2012  
REV:0 10.10.2019

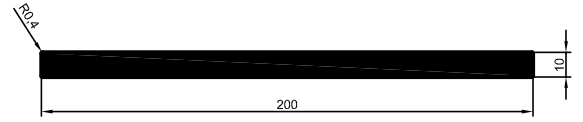

4679  
5,420 kg/m

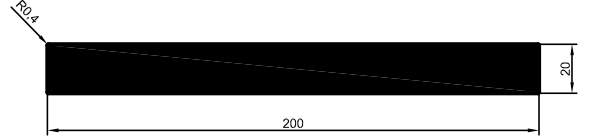

4680  
10,840 kg/m

26

4.01 L.03 REV:0 12.01.2012  
REV:0 10.10.2019

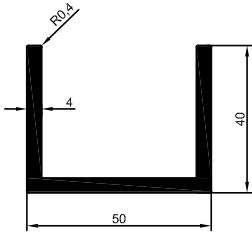

4674  
1,322 kg/m

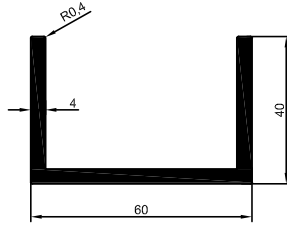

4675  
1,430 kg/m

27

4.01 L.03 REV:0 12.01.2012  
REV:0 10.10.2019

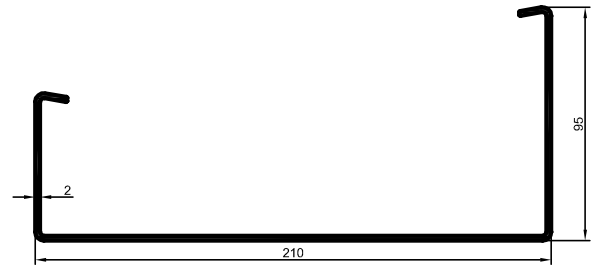

4640  
2,054 kg/m

28

4.01 L.03 REV:0 12.01.2012  
REV:0 10.10.2019