

4618
0,809 kg/m

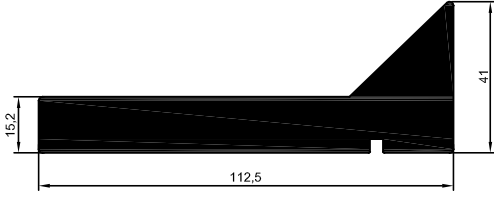

4619
5,629 kg/m

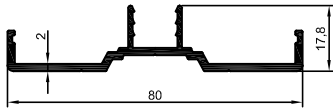

4620
0,627 kg/m

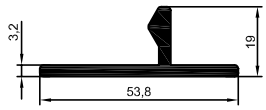

4621
0,645 kg/m

1

4.01 L.03 REV:0 12.01.2012
REV:0 24.04.2019

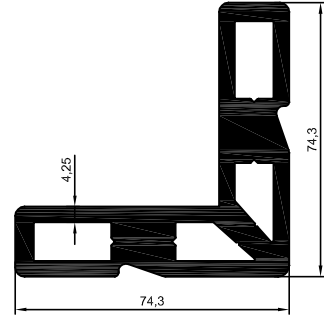

4622
4,391 kg/m

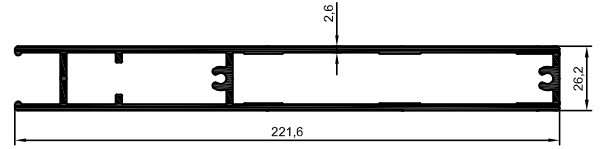

4623
3,930 kg/m

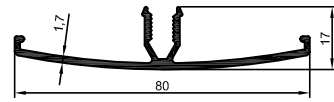

4624
0,538 kg/m

2

4.01 L.03 REV:0 12.01.2012
REV:0 24.04.2019

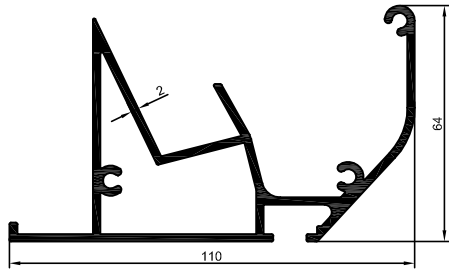

4625
2,036 kg/m



4626
0,324 kg/m

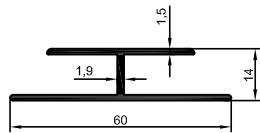

4627
0,460 kg/m

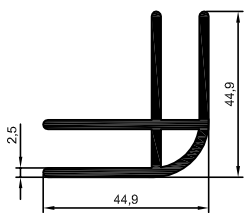

4628
1,101 kg/m

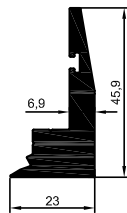

4630
1,095 kg/m

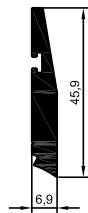

4631
0,659 kg/m

3

4.01 L.03 REV:0 12.01.2012
REV:0 24.04.2019