

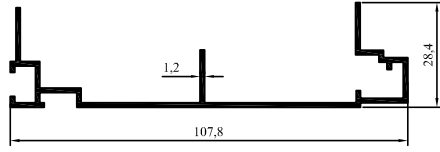

ÖZEN ALÜMİNYUM

GÜNEŞ
SOLAR ENERJİSİ
PROFİLLERİ



86-46
0,672 kg/m

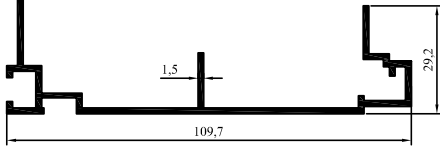

86-66
0,976 kg/m

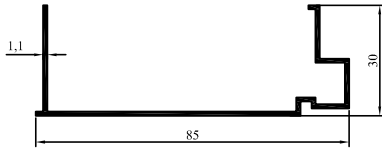

80-1
0,496 kg/m

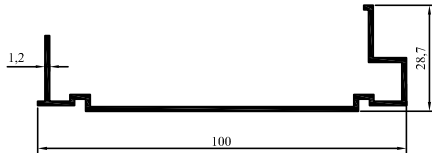

88-10
0,532 kg/m

1

4.01 L.03 REV:0 12.01.2012
REV:0 02.10.2015



ÖZEN ALÜMİNYUM

GÜNEŞ
SOLAR ENERJİSİ
PROFİLLERİ



83-31
0,444 kg/m

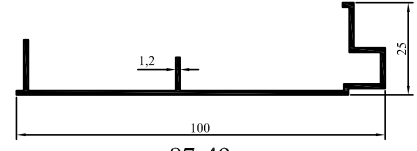

87-49
0,508 kg/m

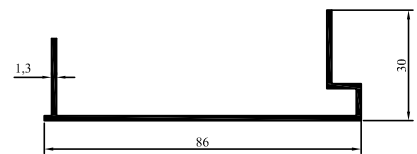

87-59
0,500 kg/m

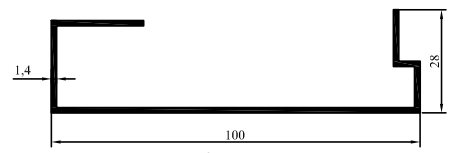

87-77
0,679 kg/m

2

4.01 L.03 REV:0 12.01.2012
REV:0 02.10.2015



ÖZEN ALÜMİNYUM

GÜNEŞ
SOLAR ENERJİSİ
PROFİLLERİ



89-44
0,569 kg/m

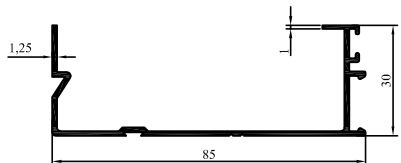

86-28
0,568 kg/m

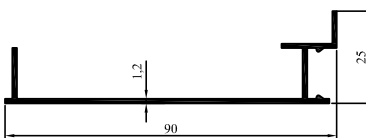

88-2
0,458 kg/m

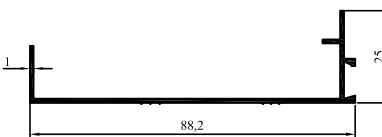

98-20
0,418 kg/m

3

4.01 L.03 REV:0 12.01.2012
REV:0 02.10.2015



ÖZEN ALÜMİNYUM

GÜNEŞ
SOLAR ENERJİSİ
PROFİLLERİ

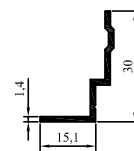

87-57
0,182 kg/m

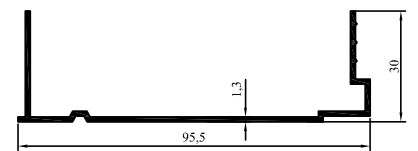

87-58
0,527 kg/m

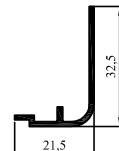

83-19
0,190 kg/m

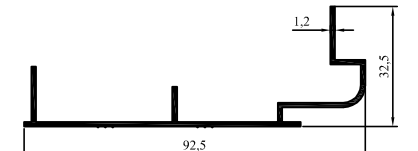

83-20
0,494 kg/m

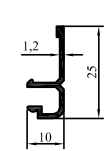

98-21
0,150 kg/m

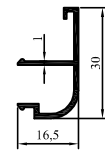

86-27
0,189 kg/m

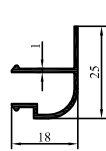

88-1
0,163 kg/m

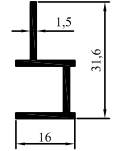

86-47
0,221 kg/m

4

4.01 L.03 REV:0 12.01.2012
REV:0 02.10.2015



ÖZEN ALÜMİNYUM

GÜNEŞ
SOLAR ENERJİSİ
PROFİLLERİ

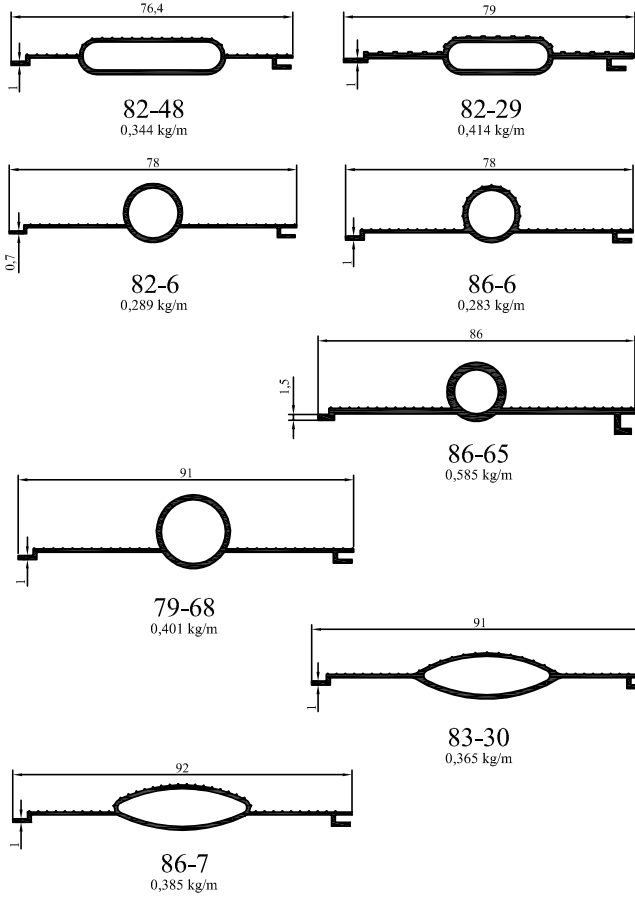

5

4.01 L.03 REV:0 12.01.2012
REV:002.10.2015



ÖZEN ALÜMİNYUM

GÜNEŞ
SOLAR ENERJİSİ
PROFİLLERİ

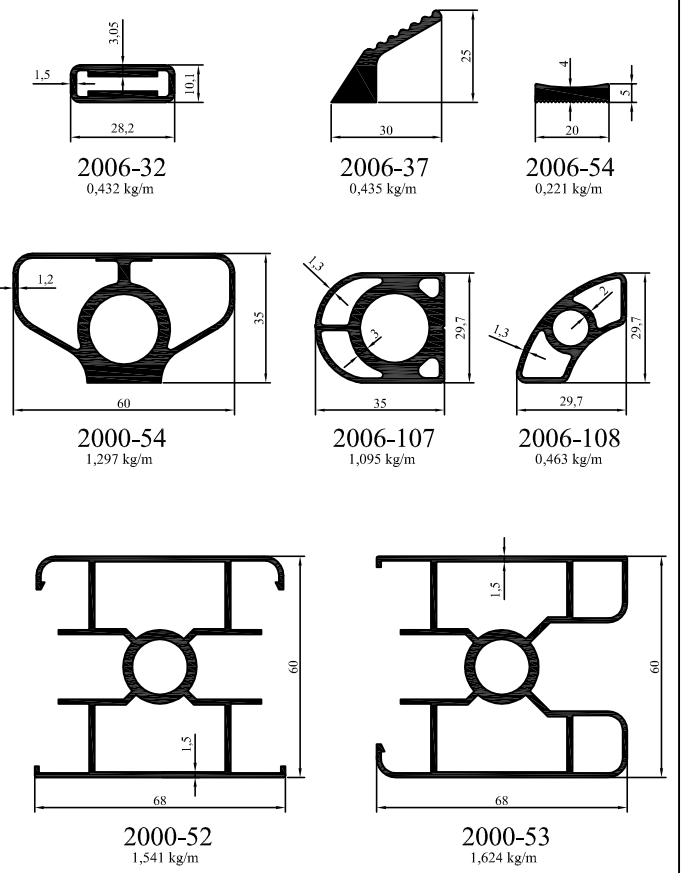

6

4.01 L.03 REV:0 12.01.2012
REV:002.10.2015



ÖZEN ALÜMİNYUM

GÜNEŞ
SOLAR ENERJİSİ
PROFİLLERİ

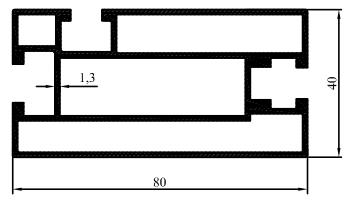
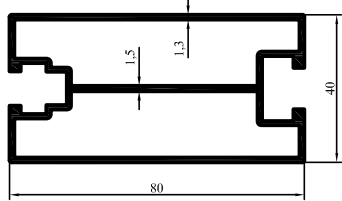
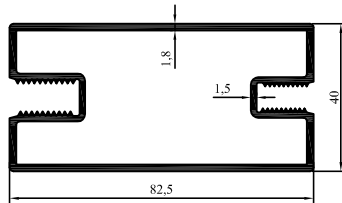

7

4.01 L.03 REV:0 12.01.2012
REV:002.10.2015



ÖZEN ALÜMİNYUM

GÜNEŞ
SOLAR ENERJİSİ
PROFİLLERİ

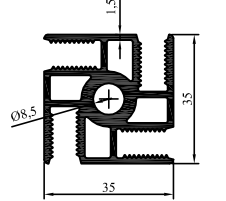
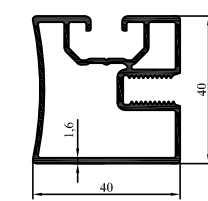
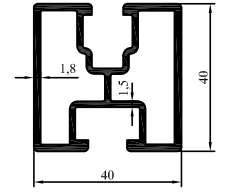
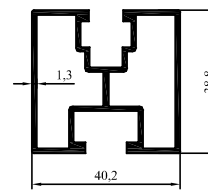
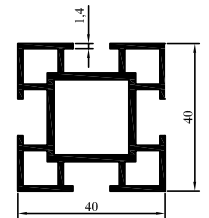
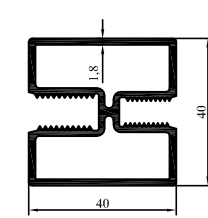

8

4.01 L.03 REV:0 12.01.2012
REV:002.10.2015



ÖZEN ALÜMİNYUM

GÜNEŞ
SOLAR ENERJİSİ
PROFİLLERİ

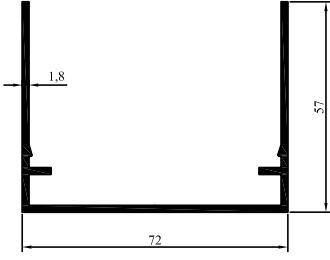

2000-51
0,952 kg/m

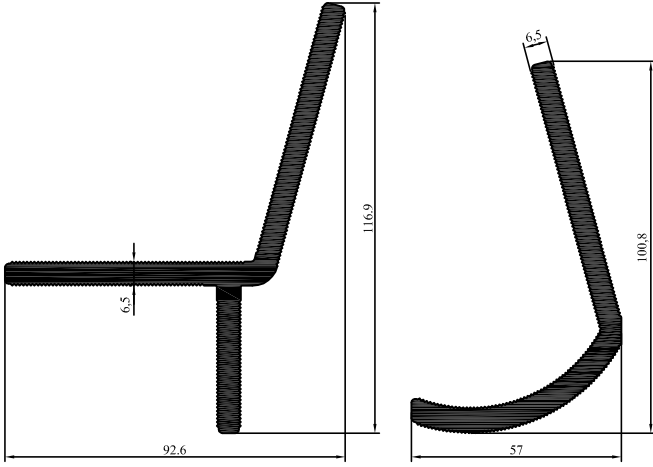

2006-53
3,018 kg/m

2006-51
2,347 kg/m

9

4.01 L.03 REV:0 12.01.2012
REV:002.10.2015



ÖZEN ALÜMİNYUM

GÜNEŞ
SOLAR ENERJİSİ
PROFİLLERİ

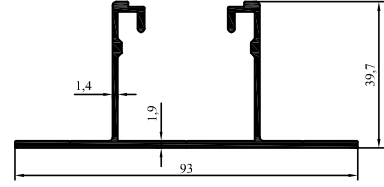

4174
0,920 kg/m

10

4.01 L.03 REV:0 12.01.2012
REV:2 06.08.2018



ÖZEN ALÜMİNYUM

GÜNEŞ
SOLAR ENERJİSİ
PROFİLLERİ

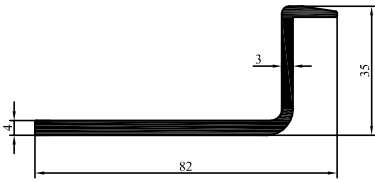

4236
1,063 kg/m

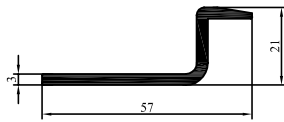

4237
0,572 kg/m

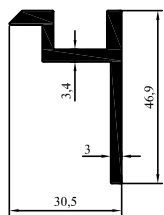

2017-36
0,744 kg/m

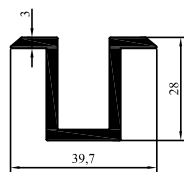

2017-37
0,708 kg/m

11

4.01 L.03 REV:0 12.01.2012
REV:1 07.09.2017



ÖZEN ALÜMİNYUM

GÜNEŞ
SOLAR ENERJİSİ
PROFİLLERİ

12

4.01 L.03 REV:0 12.01.2012
REV:1 06.08.2018