

2953
0,672 kg/m

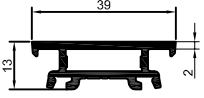

2959
1,090 kg/m



2006-135
0,500 kg/m

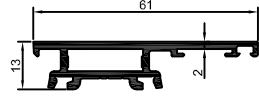

2006-136
0,644 kg/m

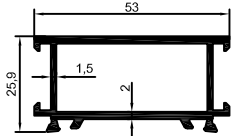

2006-61
0,808 kg/m

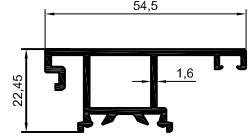

2956
0,633 kg/m

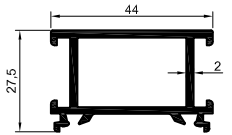

2952
0,765 kg/m



2958
1,260 kg/m

1

4.01 L.03 REV:0 12.01.2012
REV:0 05.10.2015

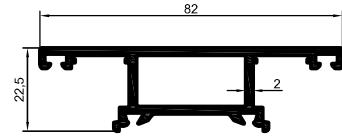

2951
0,934 kg/m



2957
1,438 kg/m

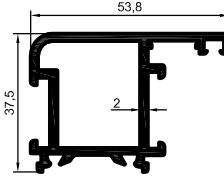

2954
0,945 kg/m

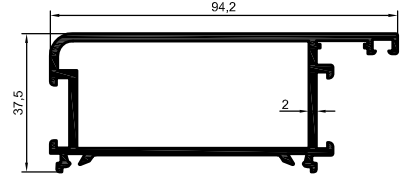

2960
1,356 kg/m

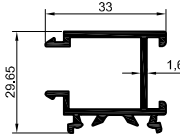

2955
0,503 kg/m

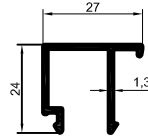

2961
0,282 kg/m

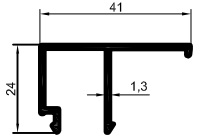

2962
0,331 kg/m

2

4.01 L.03 REV:0 12.01.2012
REV:0 05.10.2015

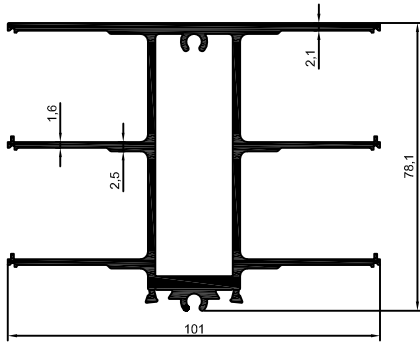

3289
2,624 kg/m

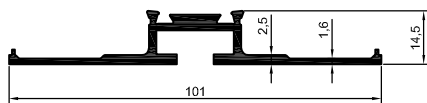

3290
0,839 kg/m

3

4.01 L.03 REV:0 12.01.2012
REV:0 05.10.2015

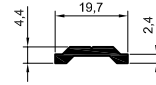

2963
0,141 kg/m

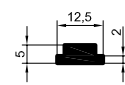

3062
0,136 kg/m

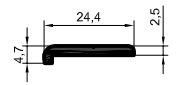

3063
0,171 kg/m

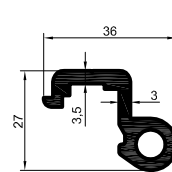

3060
0,695 kg/m

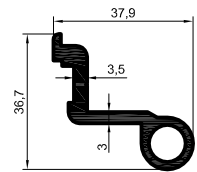

3061
0,665 kg/m

4

4.01 L.03 REV:0 12.01.2012
REV:0 05.10.2015

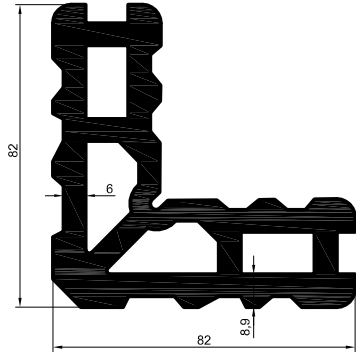

3064
6,394 kg/m

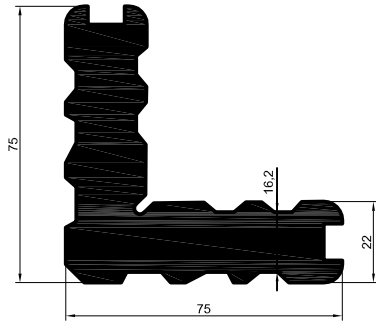

3065
6,480 kg/m

5

4.01 L.03 REV:012.01.2012
REV:005.10.2015

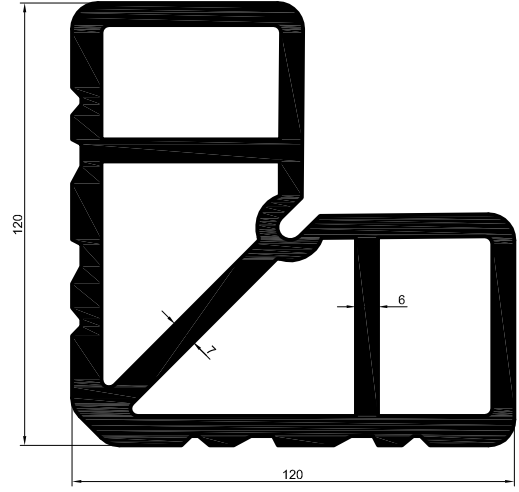

3066
10,848 kg/m

6

4.01 L.03 REV:012.01.2012
REV:005.10.2015