

3526
0,505 kg/m

3086
0,539 kg/m

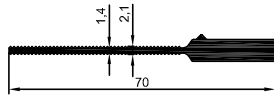

3527
0,573 kg/m

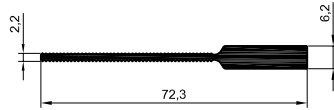

2946
0,628 kg/m

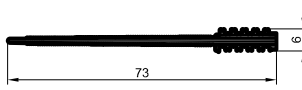

2008-34-B
0,484 kg/m

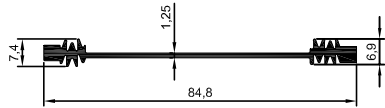

3655
0,477 kg/m

1

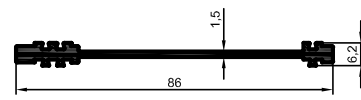

3660
0,547 kg/m

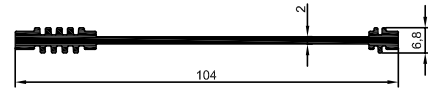

3670
0,803 kg/m

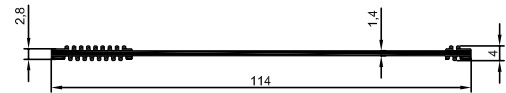

3671
0,540 kg/m

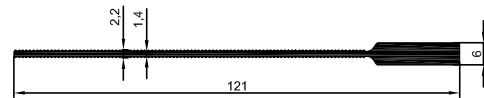

4012
0,854 kg/m

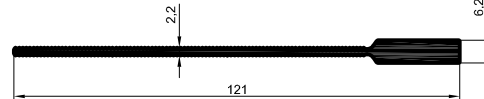

2914
0,866 kg/m

2

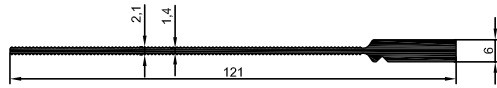

3544
0,752 kg/m

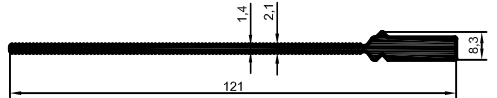

3085
0,786 kg/m



3545
0,821 kg/m

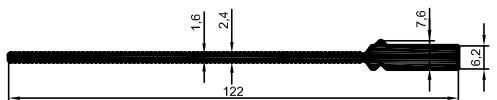

4092
0,953 kg/m

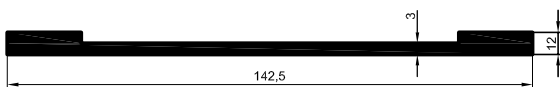

2008-51-B
1,484 kg/m

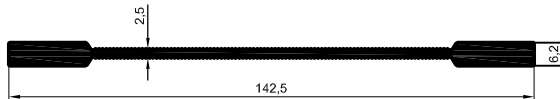

2008-50-B
1,267 kg/m

3

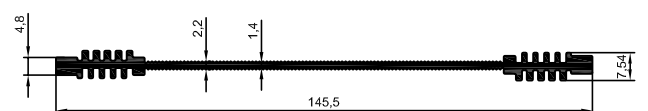

3672
1,089 kg/m

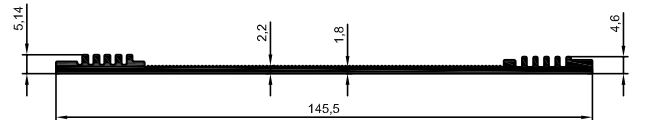

3680
0,978 kg/m

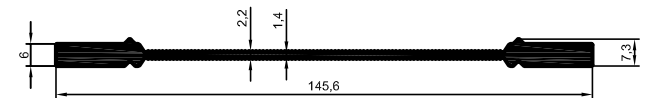

3076
1,237 kg/m

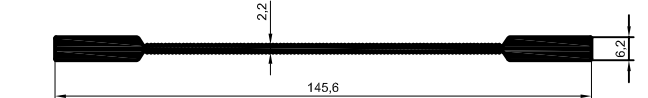

2969
1,262 kg/m

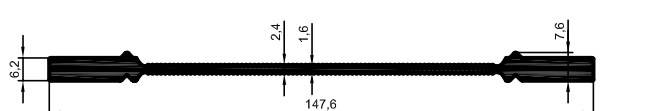

4093
1,366 kg/m

4

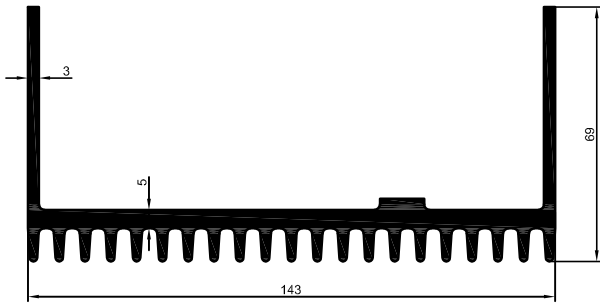

3220
4.207 kg/m

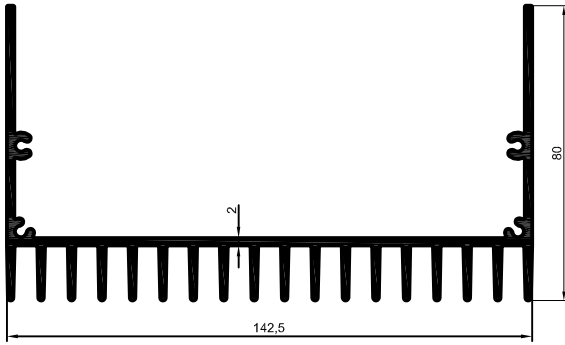

3080
2.916 kg/m

5

4.01 L.03 REV:0 12.01.2012
REV:0 06.10.2015

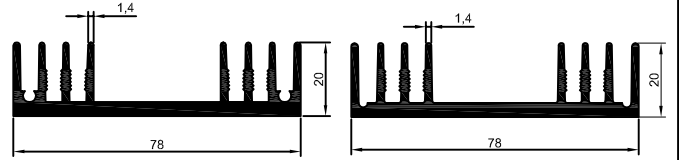

90-2
1,470 kg/m

82-47
1,429 kg/m

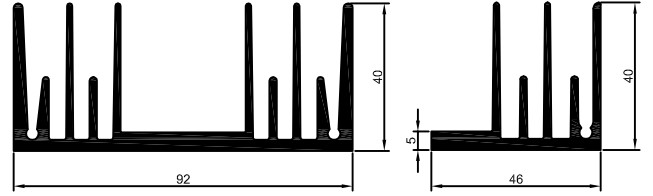

88-54
2,648 kg/m

90-1
1,196 kg/m

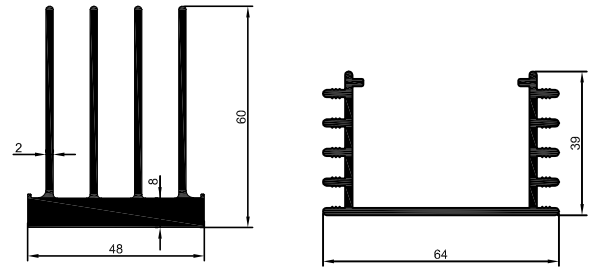

3852
2,181 kg/m

89-72
1,035 kg/m

6

4.01 L.03 REV:0 12.01.2012
REV:0 06.10.2015

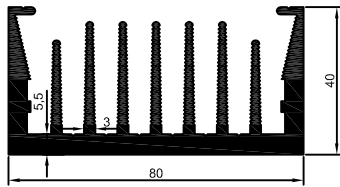

2006-121
3,465 kg/m

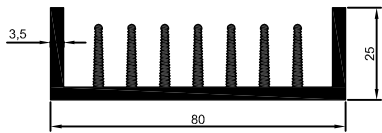

2010-08
1,853 kg/m

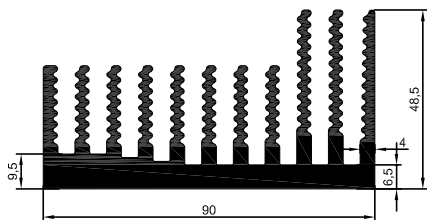

4069
4,426 kg/m

7

4.01 L.03 REV:0 12.01.2012
REV:1 28.04.2016

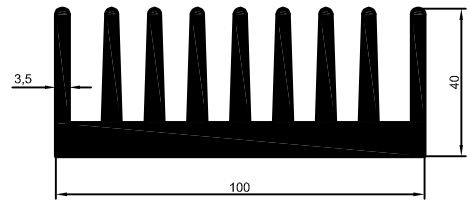

2927
5,357 kg/m

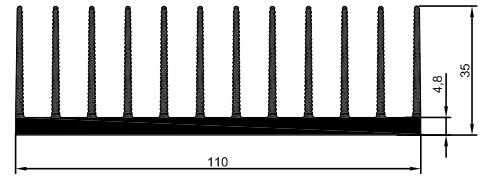

3818
3,058 kg/m

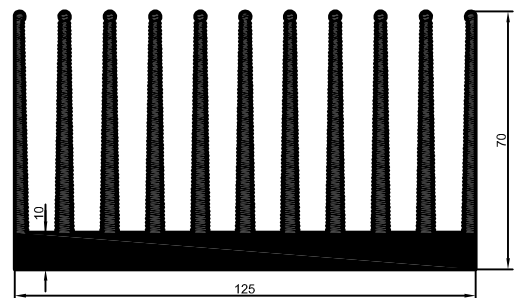

2906
8,552 kg/m

8

4.01 L.03 REV:0 12.01.2012
REV:1 28.04.2016

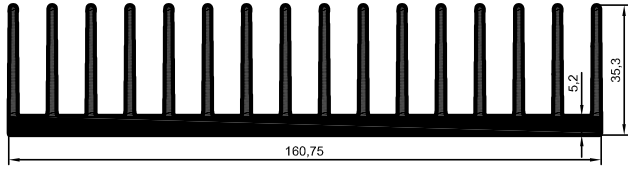

4071

5,052 kg/m

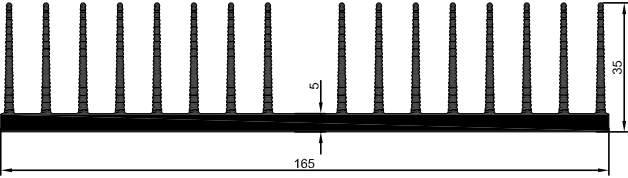

3819

4,549 kg/m

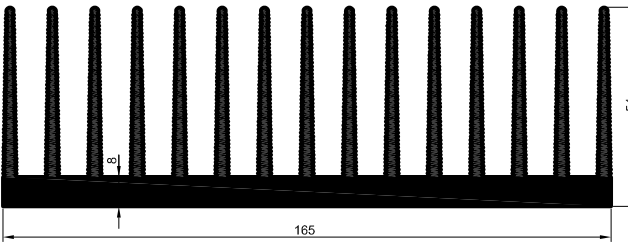

3018

8,245 kg/m

9

4.01 L.03 REV:0 12.01.2012
REV:1 28.04.2016

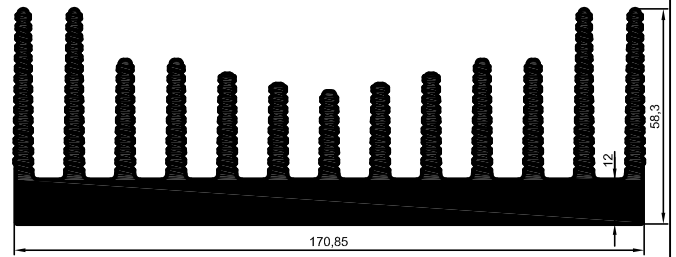

4178

10,343 kg/m

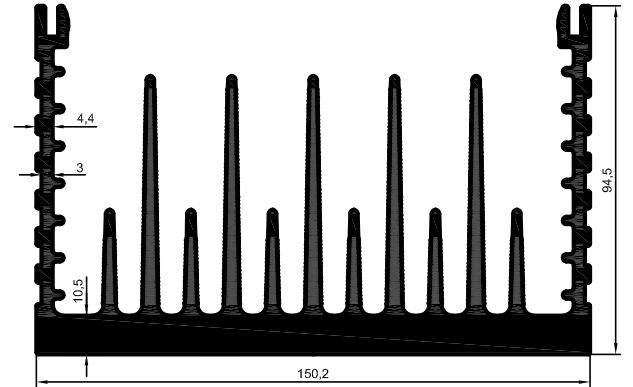

4167

10,554 kg/m

10

4.01 L.03 REV:0 12.01.2012
REV:1 21.12.2016

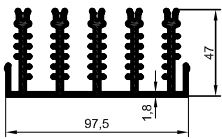

2970

2,987 kg/m

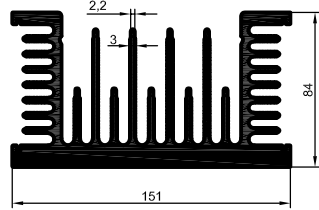

2971

11,837 kg/m

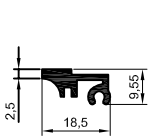

2006-123

0,223 kg/m

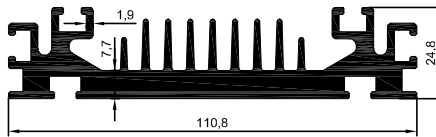

2014-121

3,483 kg/m

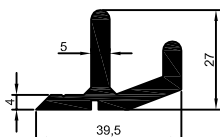

2006-122

0,876 kg/m

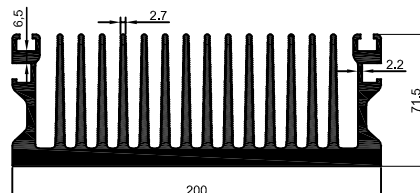

2972

16,053 kg/m

11

4.01 L.03 REV:0 12.01.2012
REV:0 06.10.2015

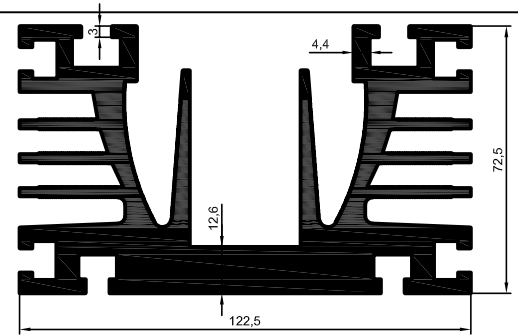

2974

9,524 kg/m

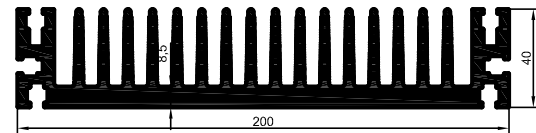

4176

9,912 kg/m

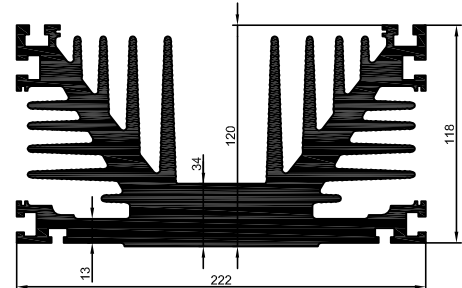

3816

32,151 kg/m

12

4.01 L.03 REV:0 12.01.2012
REV:1 21.12.2016

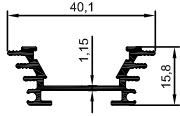

2014-117
0,349 kg/m

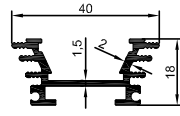

3817 / 2017-23
0,437 kg/m

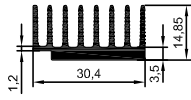

3947
0,549 kg/m

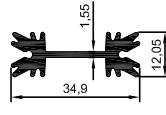

3959
0,465 kg/m

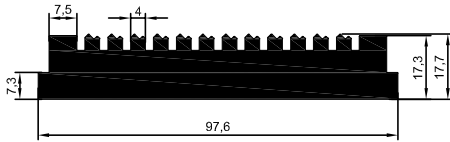

3830
4,066 kg/m

13

4.01 L.03 REV:0 12.01.2012
REV:118.04.2017

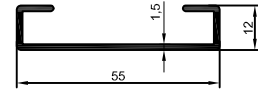

2926
0,374 kg/m

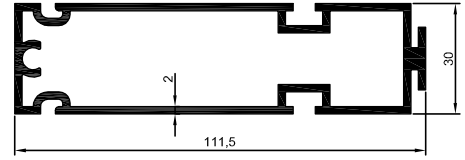

3188
1,890 kg/m

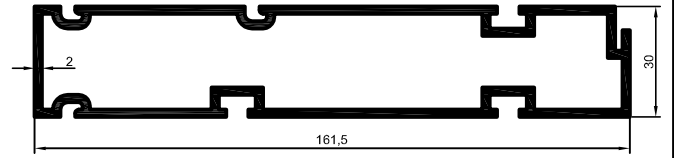

3187
2,449 kg/m

14

4.01 L.03 REV:0 12.01.2012
REV:006.10.2015

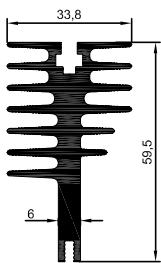

3992
1,734 kg/m

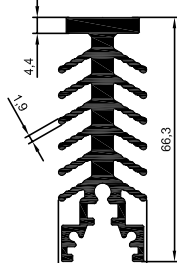

4121
1,809 kg/m

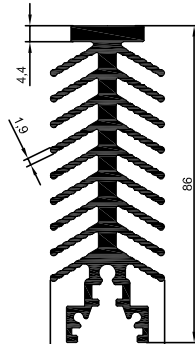

4122
2,650 kg/m

15

4.01 L.03 REV:0 12.01.2012
REV:2 07.10.2016

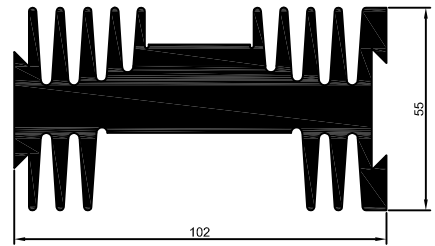

88-11
7,443 kg/m

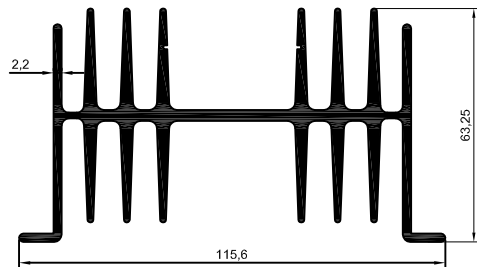

3021
3,791 kg/m

16

4.01 L.03 REV:0 12.01.2012
REV:0 28.04.2016

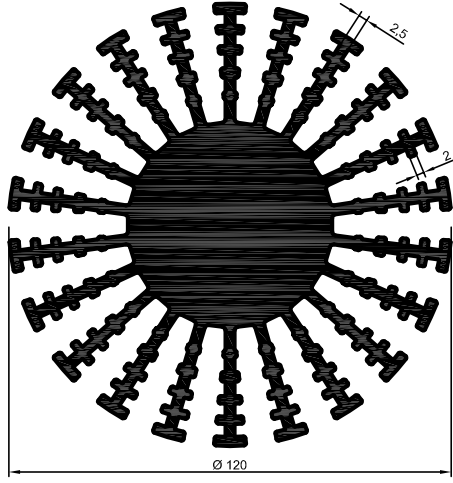

4067
13,697 kg/m

4.01 L.03 REV:0 12.01.2012
REV:0 28.04.2016

17

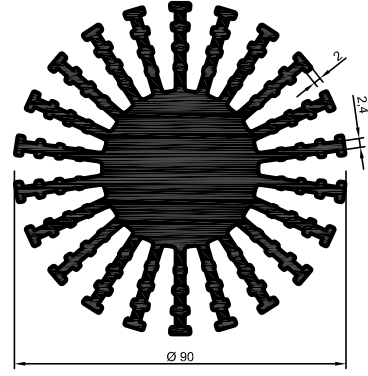

4068
8,099 kg/m

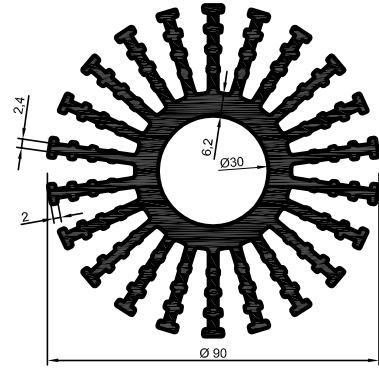

4124
6,184 kg/m

4.01 L.03 REV:0 12.01.2012
REV:1 07.10.2016

18

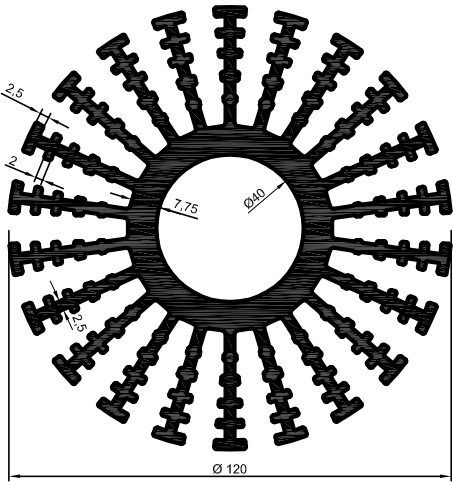

4123
10,292 kg/m

4.01 L.03 REV:0 12.01.2012
REV:0 07.10.2016

19



20

4.01 L.03 REV:0 12.01.2012
REV:1 13.12.2019

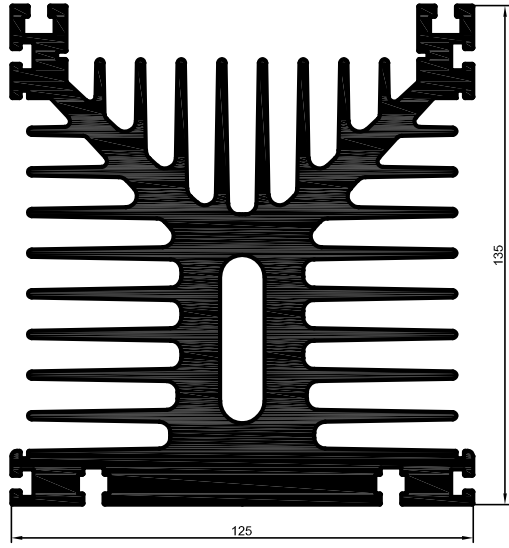

4175
18,464 kg/m

21

4.01 L.03 REV:0 12.01.2012
REV:0 21.12.2016

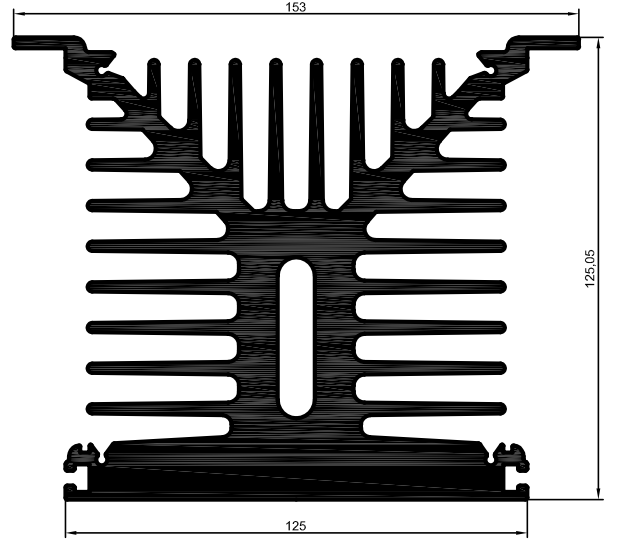

4301
18,354 kg/m

22

4.01 L.03 REV:0 12.01.2012
REV:1 08.09.2017

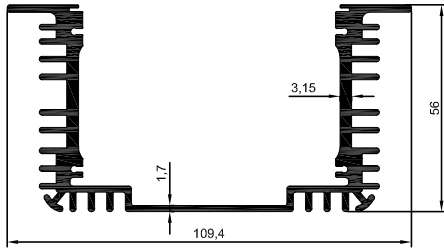

3429
2,383 kg/m

23

4.01 L.03 REV:0 12.01.2012
REV:2 08.09.2017

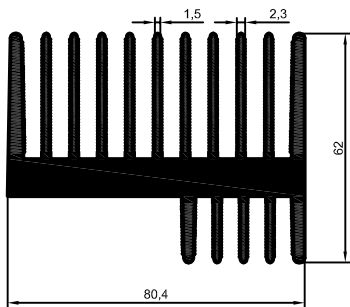

3242
4,984 kg/m

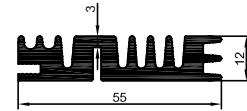

4222
1,174 kg/m

24

4.01 L.03 REV:0 12.01.2012
REV:1 11.09.2017

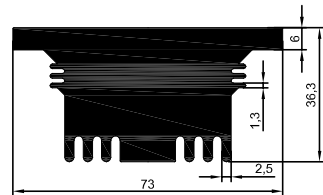

2011-47
4,772 kg/m



ÖZEN ALÜMİNYUM SOĞUTUCU PROFİLLERİ

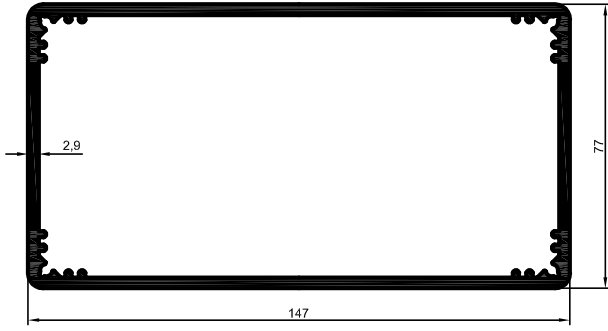

4318
3,615 kg/m

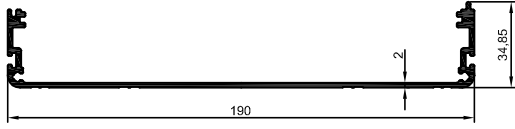

4331
1,603 kg/m

25

4.01 L.03 REV:0 12.01.2012
REV:1 31.10.2017



ÖZEN ALÜMİNYUM SOĞUTUCU PROFİLLERİ

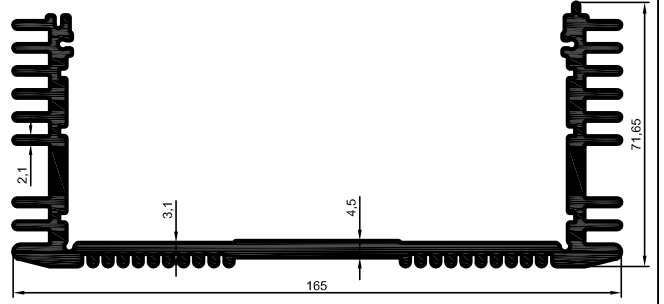

4136
4,537 kg/m

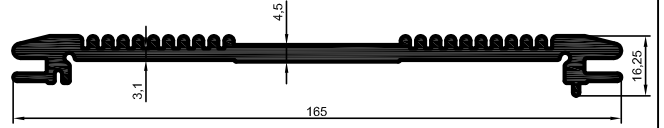

4142
2,498 kg/m

26

4.01 L.03 REV:0 12.01.2012
REV:0 11.09.2017



ÖZEN ALÜMİNYUM SOĞUTUCU PROFİLLERİ

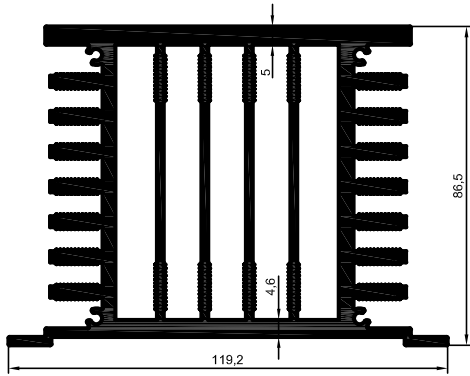

4168
7,603 kg/m

27

4.01 L.03 REV:0 12.01.2012
REV:0 13.03.2018



ÖZEN ALÜMİNYUM SOĞUTUCU PROFİLLERİ

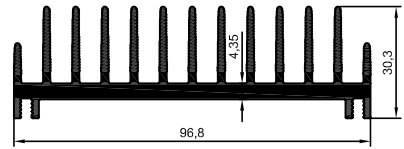

4472
2,480 kg/m

28

4.01 L.03 REV:0 12.01.2012
REV:0 03.08.2018

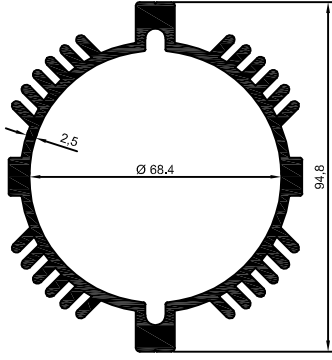

2003-14
3,280 kg/m

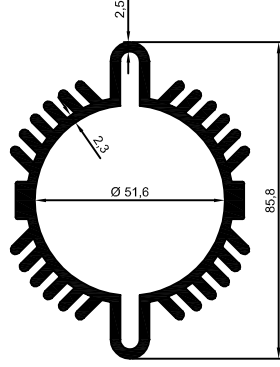

2003-15
2,776 kg/m

29

4.01 L.03 REV:012.01.2012
REV:011.09.2017

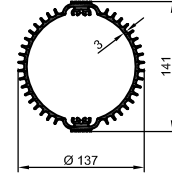

2008-73-A
5,366 kg/m

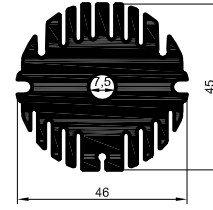

2008-79-B
3,368 kg/m

30

4.01 L.03 REV:012.01.2012
REV:011.09.2017



31

32

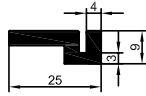

4365
0,374 kg/m

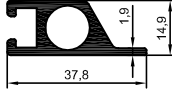

2018-37
0,572 kg/m

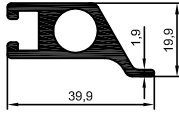

2018-38
0,689 kg/m

33

4.01 L.03 REV:0 12.01.2012
REV:1 26.11.2018

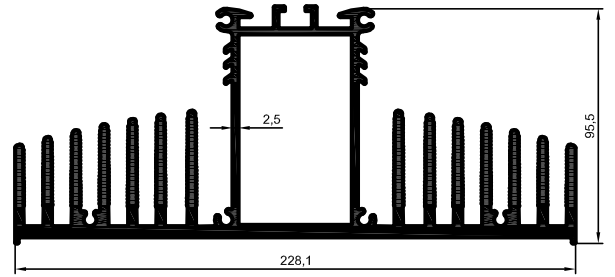

4377
10,281 kg/m

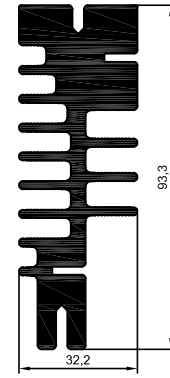

4411
3,987 kg/m

34

4.01 L.03 REV:0 12.01.2012
REV:0 13.03.2018

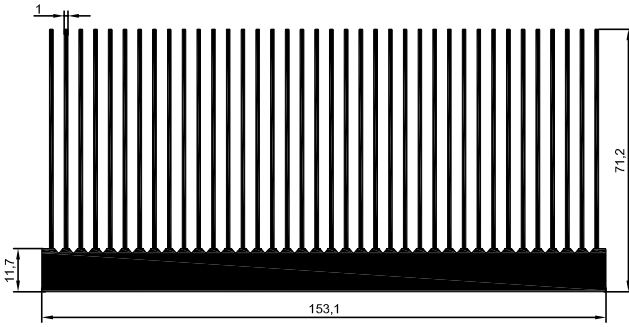

3948 - 3949
10,713 kg/m

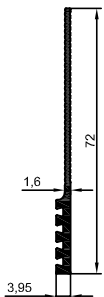

4415
0,372 kg/m

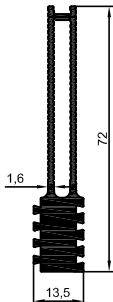

4416
1,051 kg/m

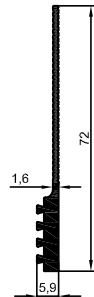

4417
0,458 kg/m

35

4.01 L.03 REV:0 12.01.2012
REV:0 13.03.2018

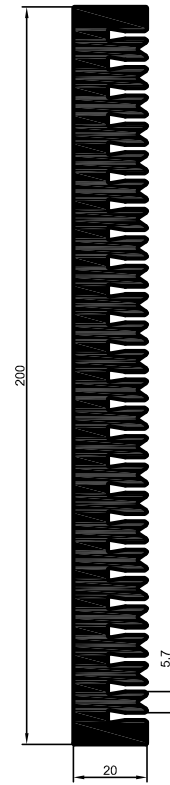

4418
8,754 kg/m

36

4.01 L.03 REV:0 12.01.2012
REV:0 13.03.2018